

The SpinQuest (E1039) Experiment: Probing the sea-quarks' Sivers asymmetry

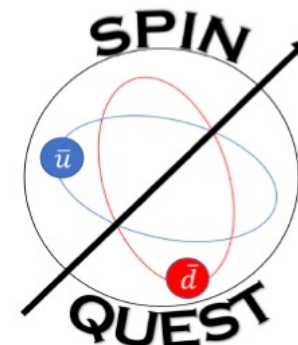

Ishara Fernando
For the SpinQuest Collaboration

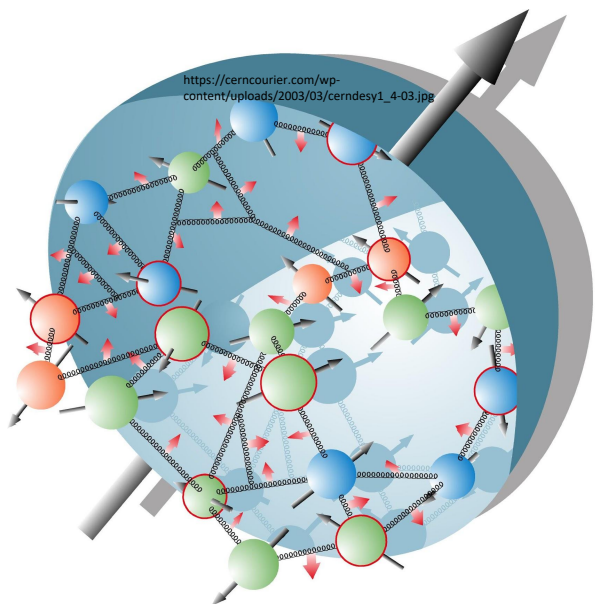

UNIVERSITY
of
VIRGINIA



U.S. DEPARTMENT OF
ENERGY

Office of
Science

Outline

- Physics motivation
- Possible missing spin contributions
- TMD PDFs, Sivers Function & Sign
- Global analyses, global context & sea-quark Sivers functions
- Polarized fixed target Drell-Yan / SpinQuest / E1039 experiment at Fermilab
- Projected Uncertainties & goodness of event-reconstruction
- SpinQuest / E1039 timeline
- SpinQuest / E1039 Goals

Physics Motivation

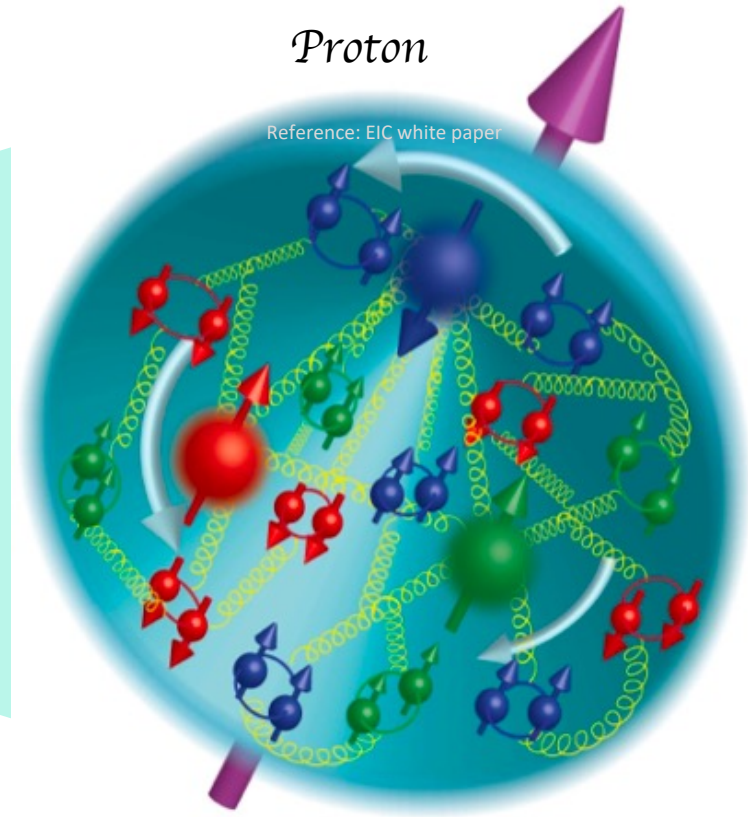
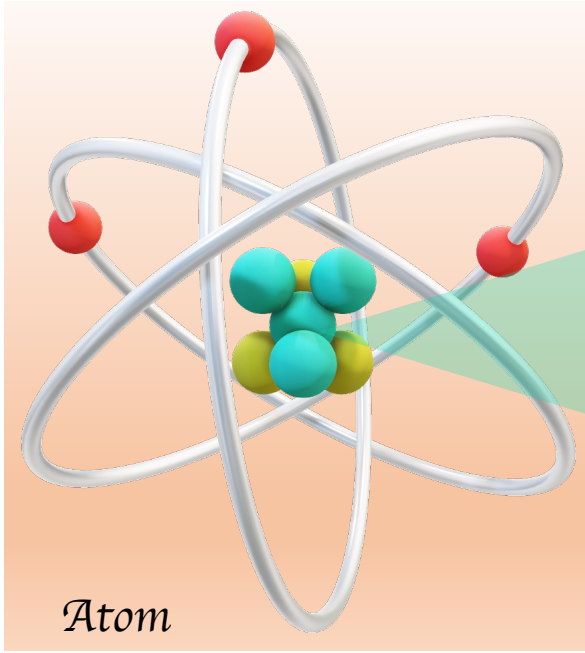

$$\begin{array}{c}
 \text{Proton Spin } (1/2) \\
 = \\
 \underbrace{\left[\begin{array}{c} \text{Valence quarks' (intrinsic) Spin} \\ \text{Sea quarks' (intrinsic) Spin} \end{array} \right]}_{\text{quarks' total intrinsic spin}} + \underbrace{\left[\begin{array}{c} \text{Valence quarks' OAM} \\ \text{Sea quarks' OAM} \end{array} \right]}_{\text{quarks' total OAM}} + \begin{array}{c} \text{Gluons (intrinsic) Spin} \\ \text{Gluons OAM} \end{array}
 \end{array}$$

OAM : Orbital Angular Momentum

Physics Motivation

Ji's decomposition

$$\frac{1}{2} = \boxed{\frac{1}{2} \sum_q \Delta q} + \sum_q L_q^z + J_g^z$$

Jaffe-Manohar decomposition

$$\frac{1}{2} = \boxed{\frac{1}{2} \sum_q \Delta q} + \sum_q \mathcal{L}^q + \Delta G + \mathcal{L}^g$$

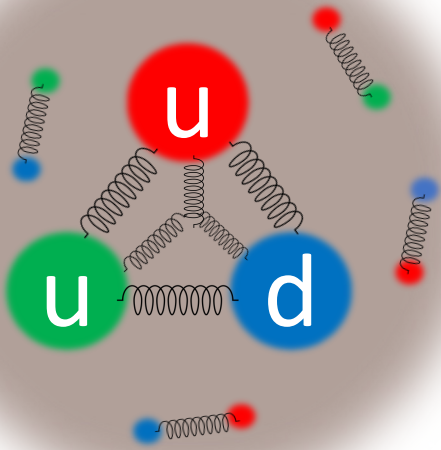

Intrinsic spin contribution
by valence & sea quarks

$$\sim (12 \pm 9 \pm 14)\%$$

$$\left(\frac{d^2\sigma}{dQ^2 d\nu} \right)^{\uparrow\downarrow} - \left(\frac{d^2\sigma}{dQ^2 d\nu} \right)^{\uparrow\uparrow} = \frac{4\pi\alpha^2}{E^2 Q^2} [M(E + E'\cos\theta)G_1(Q^2, \nu) - Q^2 G_2(Q^2, \nu)]$$

QCD Corrected
Quark Parton Model
(Ellis-Jaffe Sum rule)

$$0.189 \pm 0.005$$

$$A = \frac{d\sigma^{\uparrow\downarrow} - d\sigma^{\uparrow\uparrow}}{d\sigma^{\uparrow\downarrow} + d\sigma^{\uparrow\uparrow}}$$

$$\int_0^1 g_1^p dx = \boxed{0.126} \pm 0.010 \pm 0.015$$

$$g_1(x) = \frac{1}{2} \sum e_i^2 (q_i^+(x) - q_i^-(x))$$

EMC Collaboration (1989)

Nuclear Physics B328 (1989) 1-35

Asymmetry measurements from Deep inelastic scattering of longitudinally polarized muons on longitudinally polarized proton

Physics Motivation

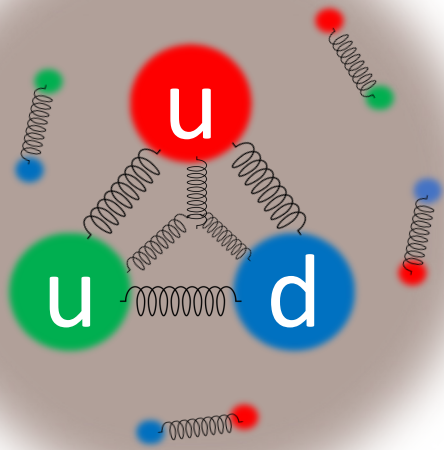

Nuclear Physics B328 (1989) 1–35

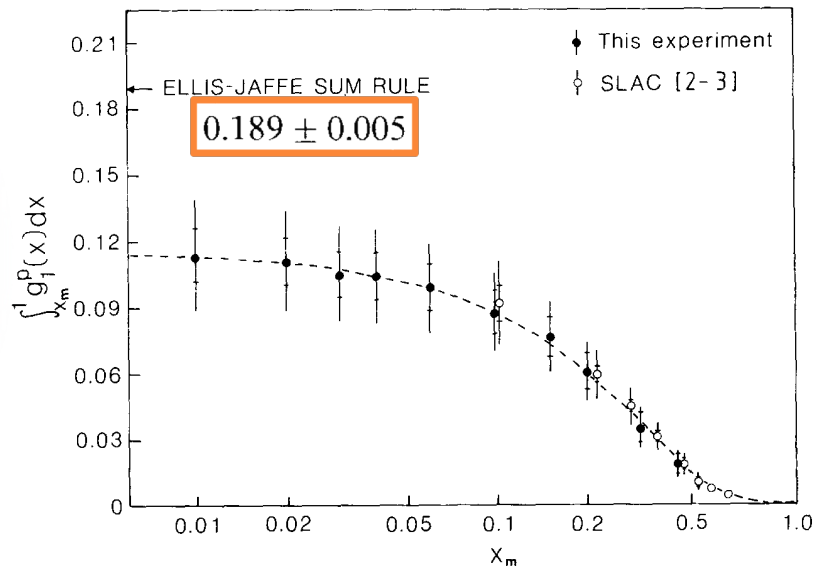

$$\int_0^1 g_1^p dx = 0.126 \pm 0.010 \pm 0.015$$

$$\langle S_z \rangle_{\text{valence}} = +0.535 \pm 0.032 \pm 0.046$$

$$\langle S_z \rangle_{\text{sea}} = -0.475 \pm 0.080 \pm 0.115$$

Intrinsic spin contribution
(total) by valence & sea quarks

$$\sim (12 \pm 9 \pm 14)\%$$

COMPASS Collaboration: Physics Letters B 753 (2016) 18–28

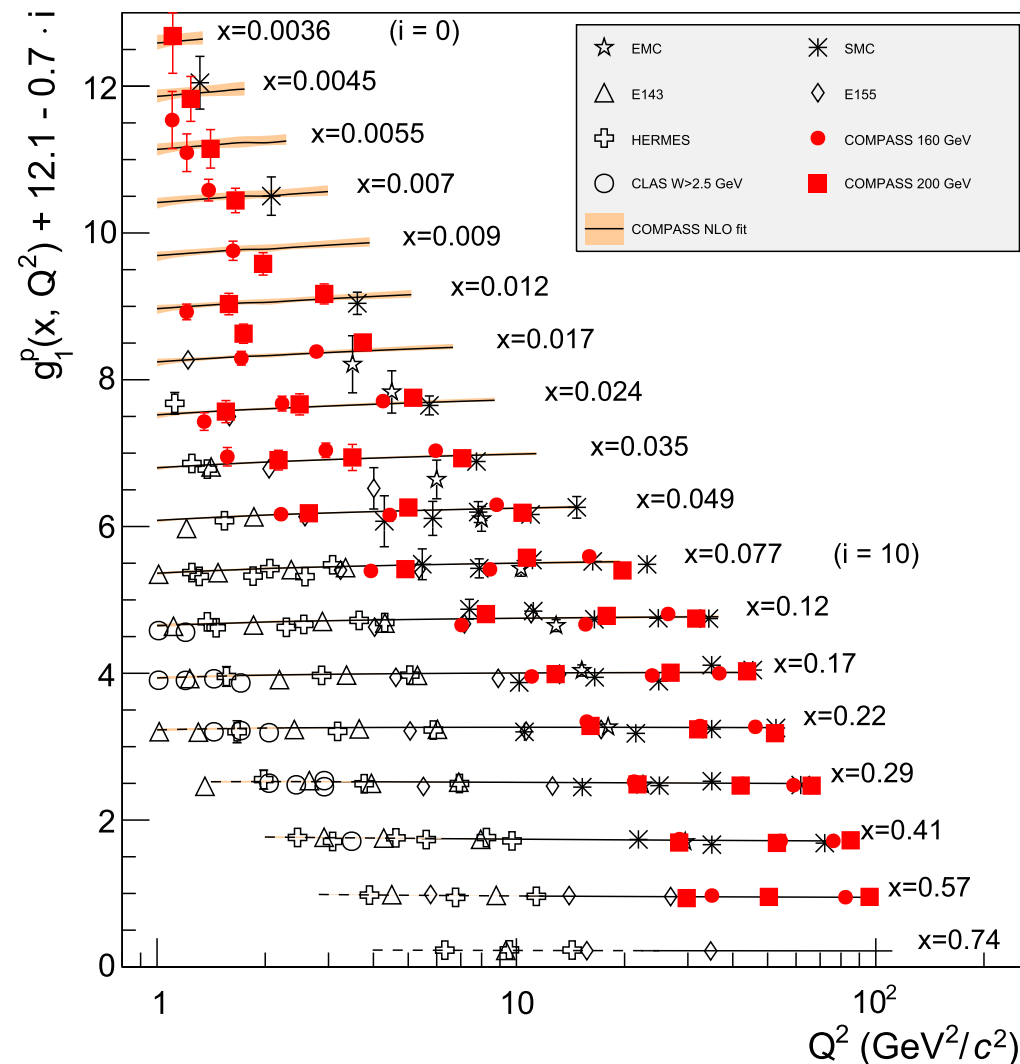

Possible missing spin contributions

K.-F. Liu et al
arXiv:1203.6388

Lattice QCD

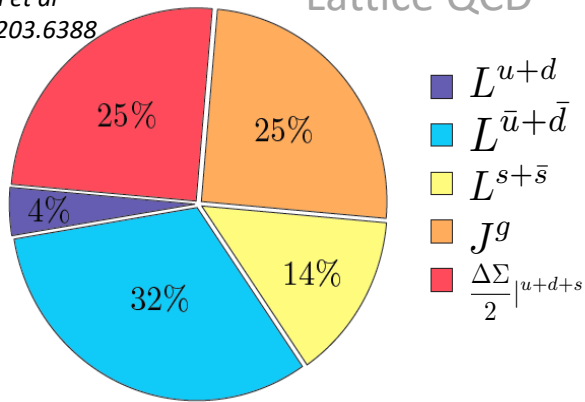

$\Delta\Sigma_q \approx 25\%$

$2 L_q \approx 50\%$ (4% (valence)+46% (sea))

$2 J_g \approx 25\%$

$$\frac{1}{2} = \frac{1}{2} \Delta\Sigma + \Delta G + L_g + L_q + L_{\bar{q}}$$

Gluon total angular momentum

Valence quarks' OAM

Sea-quarks' OAM

Jaffe-Manohar decomposition

- Sea quark OAM could be a major contribution (J. Ellis and M. Karliner, Phys. Lett. B213 (1988) 73)
- Separation of gluon intrinsic spin and OAM is constrained by gauge invariance

C. Alexandrou et al
PRL 119, 142002 (2017)

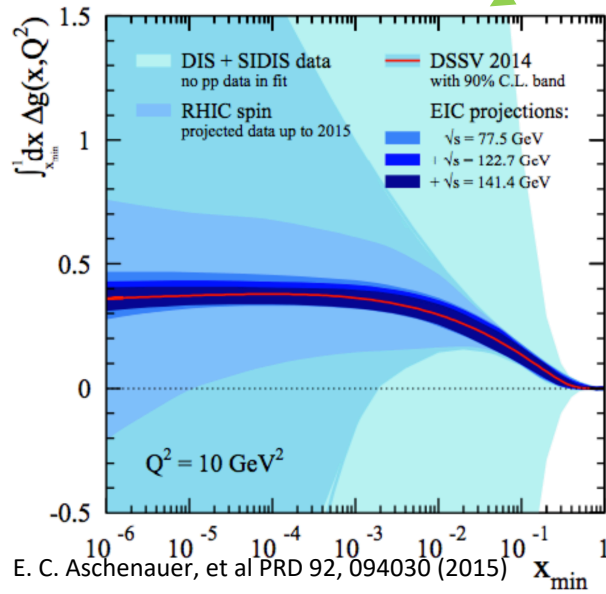

	$\frac{1}{2} \Delta\Sigma$	J	L	$\langle x \rangle$
u	0.415(13)(2)	0.308(30)(24)	-0.107(32)(24)	0.453(57)(48)
d	-0.193(8)(3)	0.054(29)(24)	0.247(30)(24)	0.259(57)(47)
s	-0.021(5)(1)	0.046(21)(0)	0.067(21)(1)	0.092(41)(0)
g	-	0.133(11)(14)	-	0.267(22)(27)
tot.	0.201(17)(5)	0.541(62)(49)	0.207(64)(45)	1.07(12)(10)

C. Alexandrou et al PRL 119, 142002 (2017)

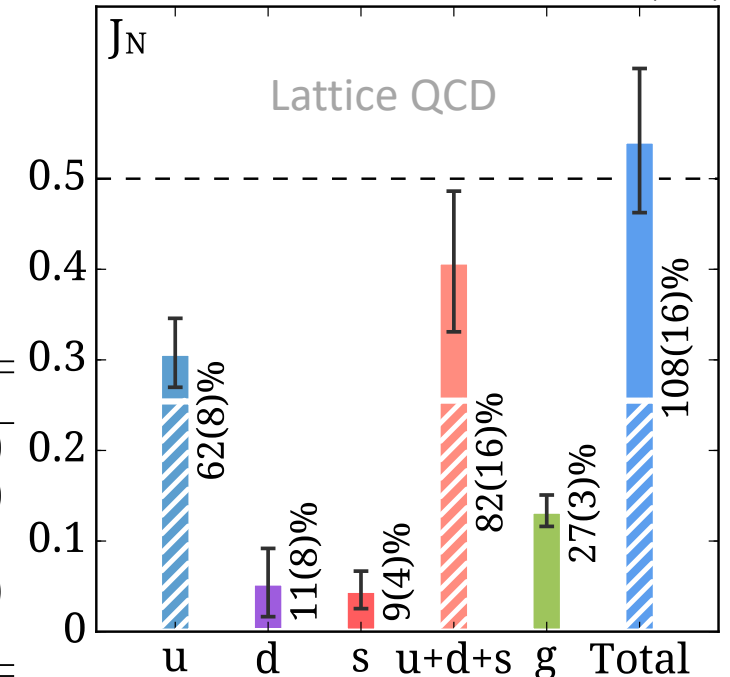

TMD PDFs

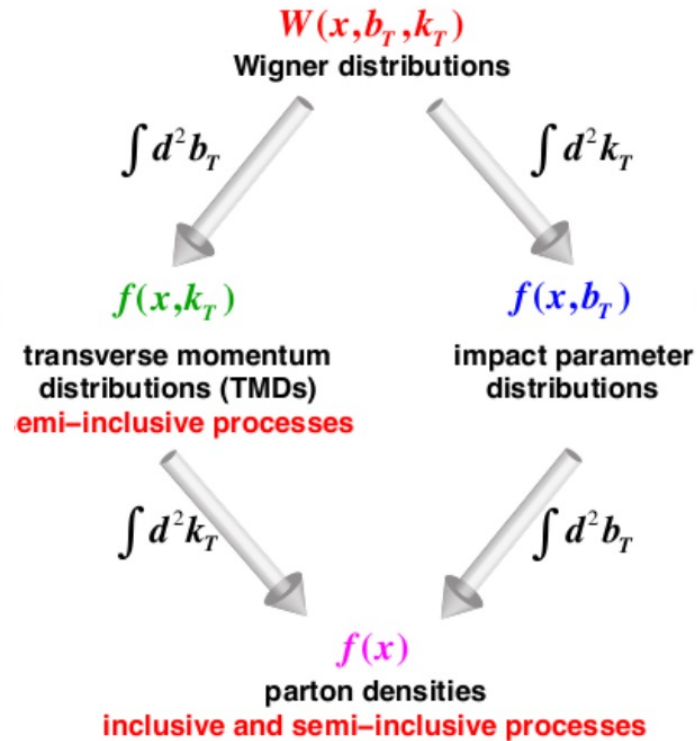
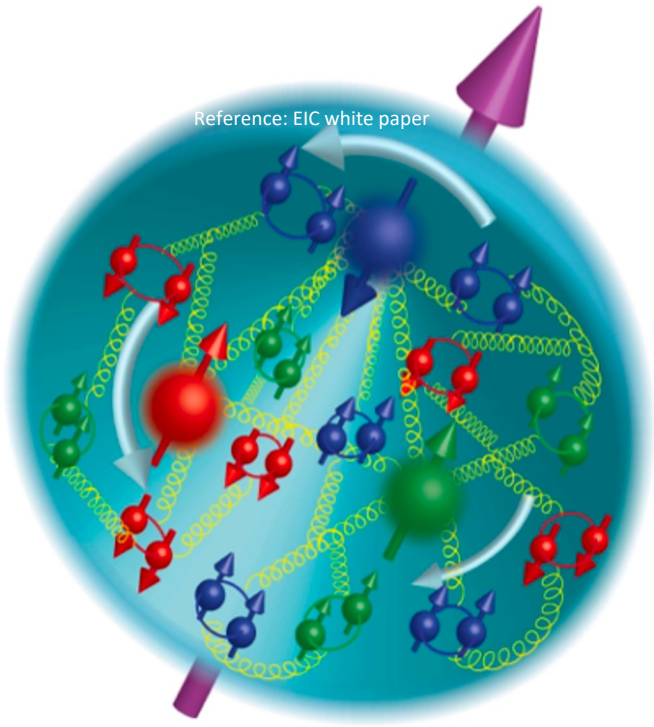

Orbital angular momentum of quarks being closely connected with their transverse position and transverse momenta since,

$$\vec{L} = \vec{r} \times \vec{p}$$

Orbital motion of quarks \rightarrow 3D momentum structure of the nucleon

Distribution functions:

- Parton Distribution Functions (PDFs) $f(x)$: The number density of partons with longitudinal momentum fraction
 - Transverse Momentum Dependent Parton Distribution Functions (TMD PDFs) : $f(x, k_T)$
- The joint distribution of partons in their longitudinal momentum fraction x , and their momentum transverse to the proton's momentum direction.

TMD PDFs

		Quark Polarization		
		U	L	T
Nucleon Polarization	U	$f_1 = \odot$	N/A	$h_1^\perp = \odot - \ominus$ Boer-Mulders
	L	N/A	$g_{1L} = \odot - \ominus$ Helicity	$h_{1L}^\perp = \odot - \ominus$
	T	$f_{1T}^\perp = \odot - \ominus$ Sivers	$g_{1T}^\perp = \odot - \ominus$	$h_1 = \odot - \ominus$ $h_{1T}^\perp = \odot - \ominus$ Transversity

$$\Phi(x, k_T; S) = \int \frac{d\xi^- d\xi_T}{(2\pi)^3} e^{ik \cdot \xi} \langle P, S | \bar{\psi}(0) \mathcal{U}_{[0, \xi]} \psi(\xi) | P, S \rangle |_{\xi^+ = 0}$$

Quark correlator can be decomposed into 8 components
(6 T-even and 2 T-odd terms) at leading-twist

$$\begin{aligned} \Phi(x, k_T, P, S) = & f_1(x, k_T^2) \frac{\not{P}}{2} + \frac{h_{1T}(x, k_T^2)}{4} \gamma_5 [\not{S}_T, \not{P}] + \frac{S_L}{2} g_{1L}(x, k_T^2) \gamma_5 \not{P} + \frac{k_T \cdot S_T}{2M} g_{1T}(x, k_T^2) \gamma_5 \not{P} \\ & + S_L h_{1L}^\perp(x, k_T^2) \gamma_5 \frac{[k_T, \not{P}]}{4M} + \frac{k_T \cdot S_T}{2M} h_{1T}^\perp(x, k_T^2) \gamma_5 \frac{[k_T, \not{P}]}{4M} \end{aligned}$$

T-even

$$+ ih_1^\perp(x, k_T^2) \frac{[k_T, \not{P}]}{4M} - \frac{\epsilon_T^{k_T S_T}}{4M} f_{1T}^\perp(x, k_T^2) \not{P}$$

T-odd

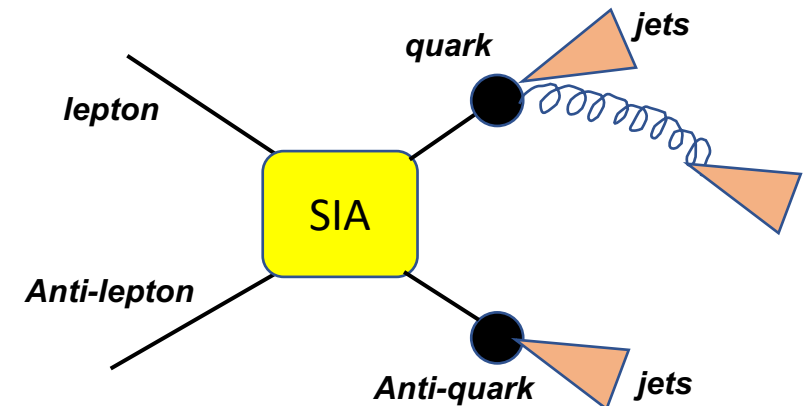
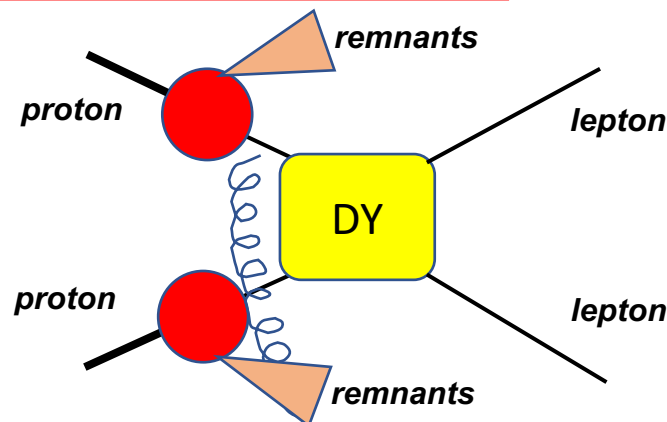
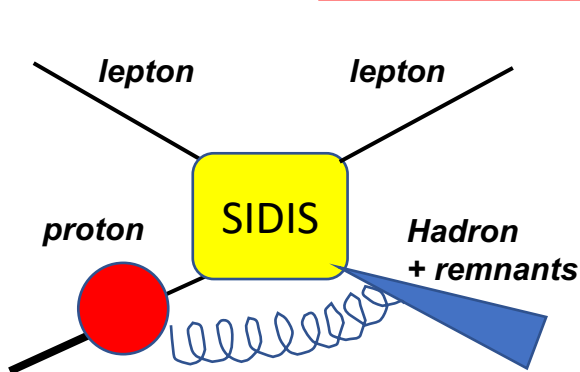

TMD PDFs

		Quark Polarization		
		U	L	T
Nucleon Polarization	U	$f_1 = \odot$	N/A	$h_1^\perp = \odot - \ominus$ Boer-Mulders
	L	N/A	$g_{1L} = \ominus - \ominus$ Helicity	$h_{1L}^\perp = \ominus - \ominus$
	T	$f_{1T}^\perp = \odot - \ominus$ Sivers	$g_{1T}^\perp = \odot - \ominus$	$h_{1T}^\perp = \odot - \ominus$ Transversity

Polarized Semi Inclusive DIS

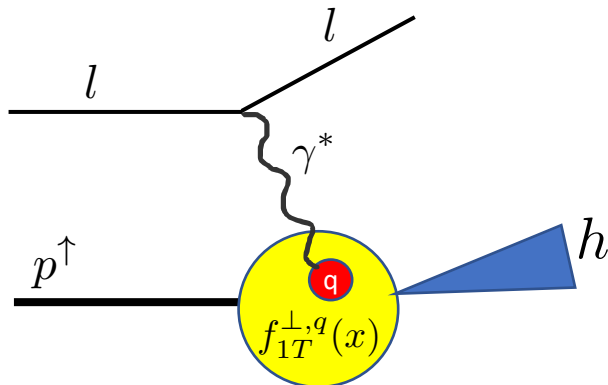

* For these two processes
TMD factorization is proven

Polarized DY

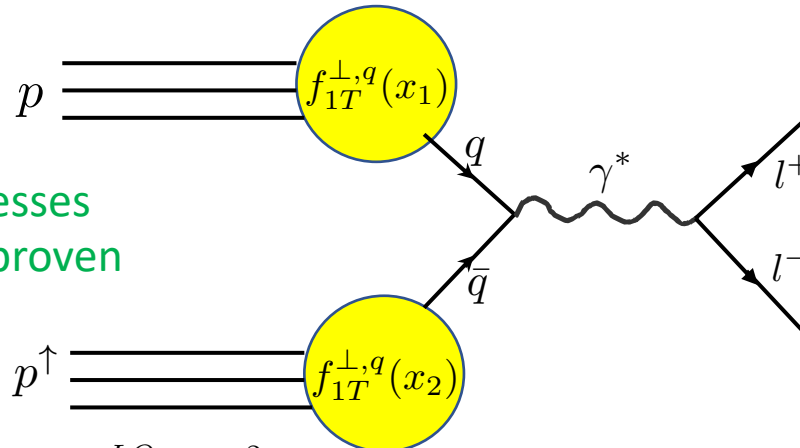

$$\frac{d\sigma_{SIDIS}^{LO}}{dx dy dz dp_T^2 d\phi_h d\psi} = \left[\frac{\alpha}{xyQ^2} \frac{y^2}{2(1-\epsilon)} \left(1 + \frac{y^2}{2x} \right) \right]$$

$$\times (F_{UU,T} + \epsilon F_{UU,L}) \left\{ 1 + \cos 2\phi_h \left(\epsilon A_{UU}^{\cos 2\phi_h} \right) \right.$$

$$\left. + S_T \left[\sin(\phi_h - \phi_s) \left(A_{UT}^{\sin(\phi_h - \phi_s)} \right) + \sin(\phi_h + \phi_s) \left(\epsilon A_{UT}^{\sin(\phi_h + \phi_s)} \right) \right. \right.$$

$$\left. \left. + \sin(3\phi_h - \phi_s) \left(\epsilon A_{UT}^{\sin(3\phi_h - \phi_s)} \right) \right] \right\}$$

$$A_{UU}^{\cos 2\phi_h} \propto h_1^{\perp q} \otimes H_{1q}^{\perp h} \quad \text{BM} \otimes \text{CF}$$

$$A_{UT}^{\sin(\phi_h - \phi_s)} \propto f_{1T}^{\perp q} \otimes D_{1q}^h \quad \text{Sivers} \otimes \text{FF}$$

$$A_{UT}^{\sin(\phi_h + \phi_s)} \propto h_1^q \otimes H_{1q}^{\perp h} \quad \text{Transv} \otimes \text{CF}$$

$$A_{UT}^{\sin(3\phi_h - \phi_s)} \propto h_{1T}^{\perp q} \otimes H_{1q}^{\perp h} \quad \text{Pretz} \otimes \text{CF}$$

$$\left. \begin{aligned} h_1^{\perp q} \Big|_{SIDIS} &= -h_1^{\perp q} \Big|_{DY} \\ f_{1T}^{\perp q} \Big|_{SIDIS} &= -f_{1T}^{\perp q} \Big|_{DY} \end{aligned} \right\}$$

$$\frac{d\sigma^{LO}}{d\Omega} = \frac{\alpha_{em}^2}{F_q} F_v^1 \left\{ 1 + \cos^2 \theta + \sin^2 \theta \cos 2\phi_{CS} A_U^{\cos 2\phi_{CS}} \right.$$

$$\left. + S_T \left[(1 + \cos^2 \theta) \sin \phi_s A_T^{\sin \phi_s} + \sin^2 \theta \left(\sin(2\phi_{CS} + \phi_s) A_T^{\sin(2\phi_{CS} + \phi_s)} \right. \right. \right.$$

$$\left. \left. + \sin(2\phi_{CS} - \phi_s) A_T^{\sin(2\phi_{CS} - \phi_s)} \right] \right\}$$

$$A_T^{\cos 2\phi_{CS}} \propto h_1^{\perp q} \otimes h_1^{\perp q} \quad \text{BM} \otimes \text{BM}$$

$$A_T^{\sin \phi_s} \propto f_1^q \otimes f_{1T}^{\perp q} \quad \text{PDF} \otimes \text{Sivers}$$

$$A_T^{\sin(2\phi_{CS} - \phi_s)} \propto h_1^{\perp q} \otimes h_1^q \quad \text{BM} \otimes \text{Transv}$$

$$A_T^{\sin(2\phi_{CS} + \phi_s)} \propto h_1^{\perp q} \otimes h_{1T}^{\perp q} \quad \text{BM} \otimes \text{Pretz}$$

$$\left. \begin{aligned} h_1^q \Big|_{SIDIS} &= h_1^q \Big|_{DY} \\ h_{1T}^{\perp q} \Big|_{SIDIS} &= h_{1T}^{\perp q} \Big|_{DY} \end{aligned} \right\}$$

Sivers Function

$$f_{q/p^\uparrow}(x, \mathbf{k}_T) = f_{q/p}(x, \mathbf{k}_T) + f_{1T}^\perp(x, \mathbf{k}_T) \mathbf{S} \cdot (\hat{\mathbf{P}} \times \hat{\mathbf{k}}_T)$$

The Sivers function describes the correlation between the momentum direction of the struck quark and the spin of its parent nucleon.

Quark Polarization

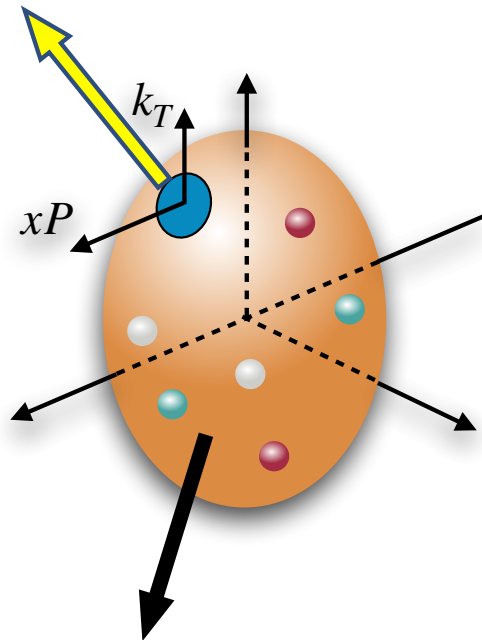

Nucleon Polarization

Pic.. Courtesy: Alexei Prokudin

Semi-Inclusive DIS

$$\sigma \sim f_{q/P}(x, k_T) D_{h/q}(z, k_T)$$

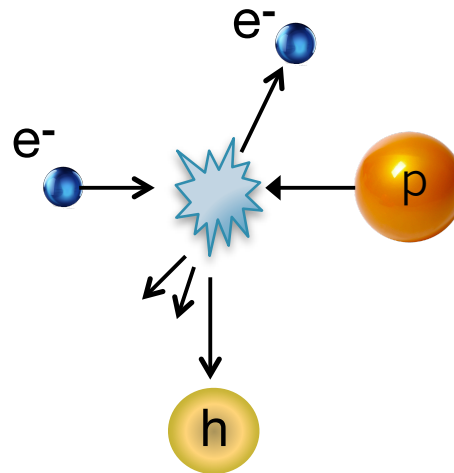

Meng, Olness, Soper (1992)
 Ji, Ma, Yuan (2005)
 Idilbi, Ji, Ma, Yuan (2004)
 Collins (2011)

Drell-Yan

$$\sigma \sim f_{q/P}(x_1, k_T) f_{\bar{q}/P}(x_2, k_T)$$

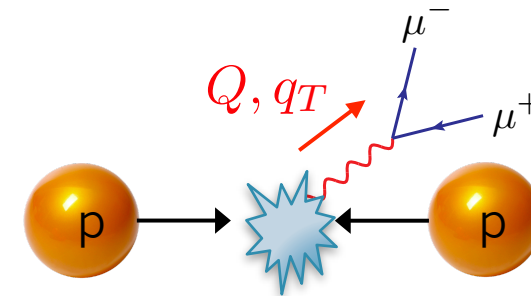

E1039

Collins, Soper, Sterman (1985)
 Ji, Ma, Yuan (2004)
 Collins (2011)

Pic.. Courtesy: Alexei Prokudin

Sivers Function

$$f_{q/p^\uparrow}(x, \mathbf{k}_T) = f_{q/p}(x, \mathbf{k}_T) + f_{1T}^\perp(x, \mathbf{k}_T) \mathbf{S} \cdot (\hat{\mathbf{P}} \times \hat{\mathbf{k}}_T)$$

The Sivers function describes the correlation between the momentum direction of the struck quark and the spin of its parent nucleon.

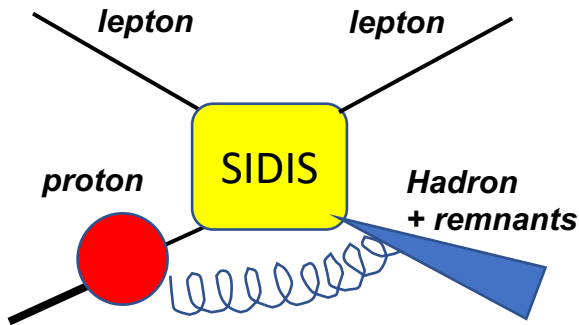

- The gauge-invariant definition of the Sivers function predicts the opposite sign for the Sivers function in SIDIS compared to processes with color charges in the initial state and a colorless final state in Drell-Yan, J/ψ , W^\pm , Z
- This inclusion of the gauge link has profound consequences on factorization proofs and on the concept of universality, which are of fundamental relevance for high-energy hadronic physics

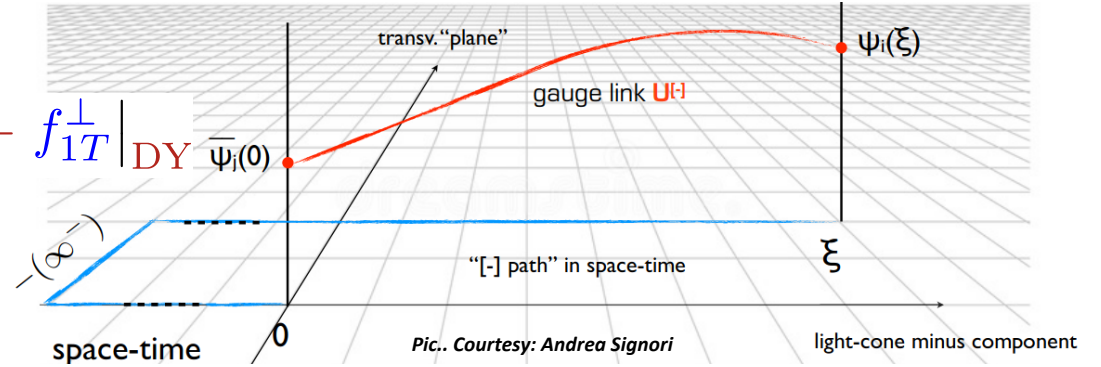
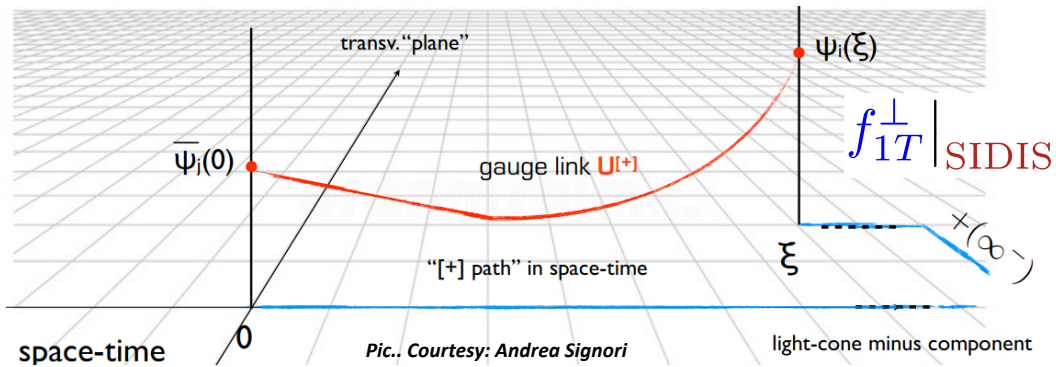
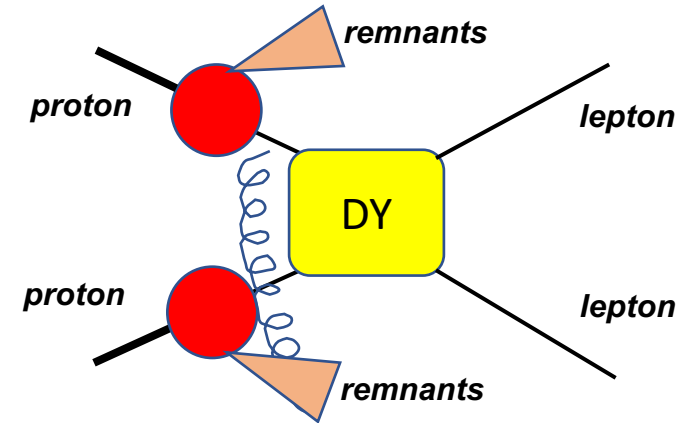

$$f_{1T}^\perp |_{\text{SIDIS}} = - f_{1T}^\perp |_{\text{DY}}$$

Sign of Sivers Functions

STAR Collaboration (PRL 116 132301 (2016))

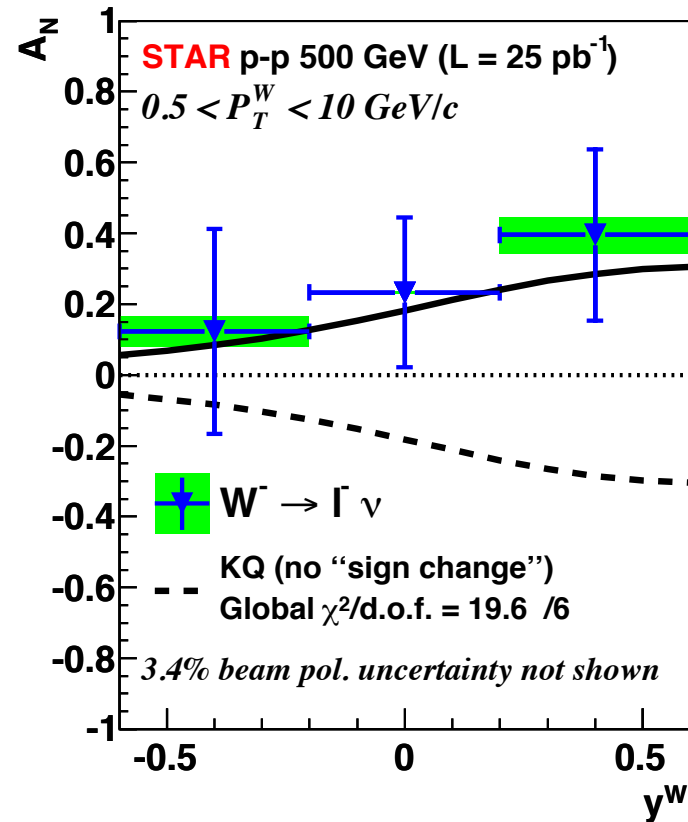
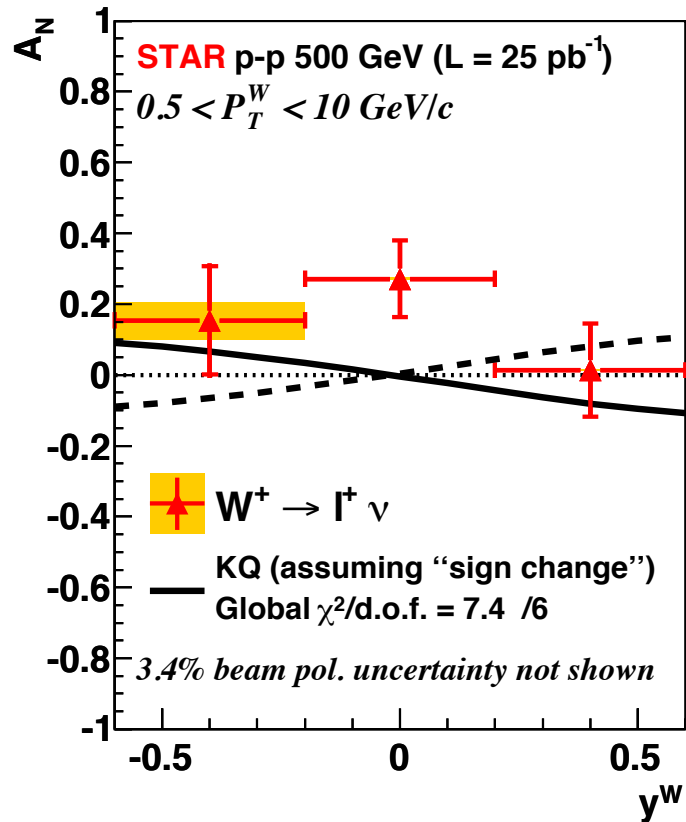

COMPASS Collaboration (PRL 119 112002 (2017))

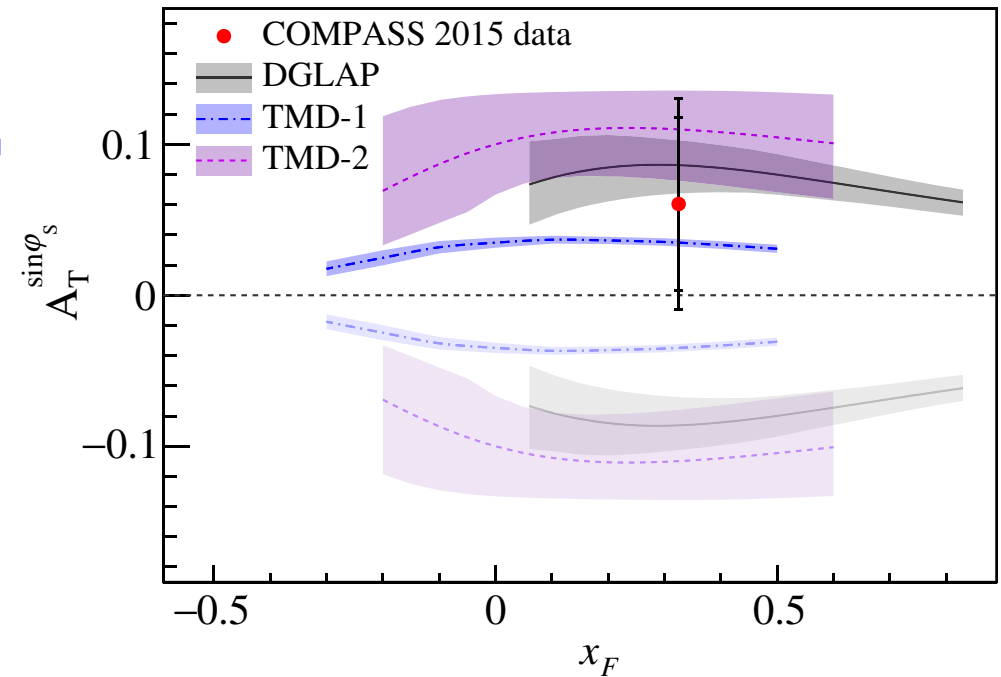

Dark Shaded (Light-shaded): with(without) “sign-change”

TSSA amplitude for W⁺/W⁻ from STAR data is favors the “sign-change”
 In DY relative to SIDIS (model based without TMD evolution)

Global analyses: Sivers functions

A. Bacchetta, F. Delcarro,
C. Pasiano, M. Radici
arXiv 2004.14278 (2020)

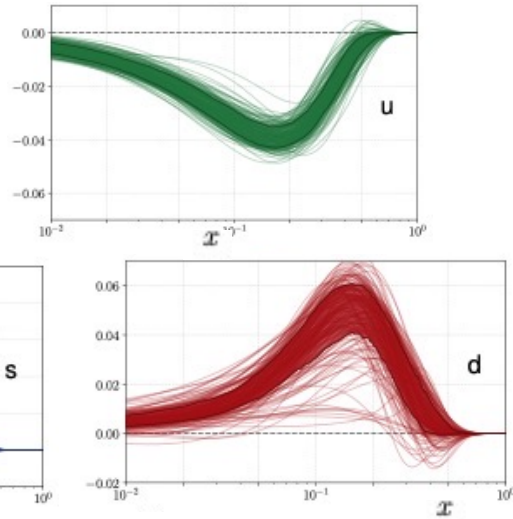

HERMES (2020)
COMPASS (2009)
COMPASS (2015)
JLab (2011)

M. Anselmino, M. Boglion, U. D'Alesio, S. Melis, F. Murgia, A. Prokudin_PRD_79_54010_(2009)

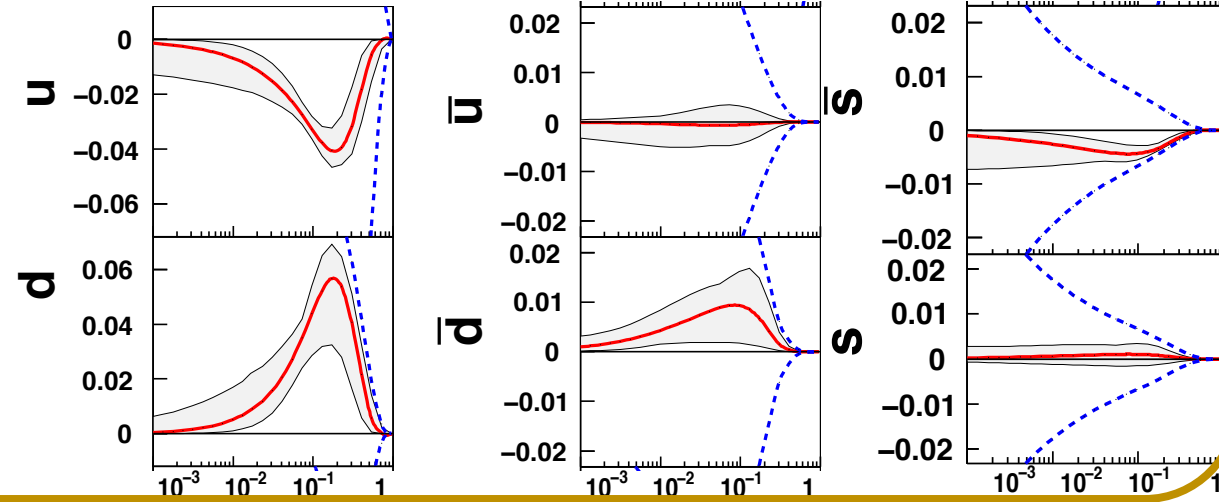

HERMES (2020), COMPASS (2009), COMPASS (2015)
JLab (2011), STAR (2016), COMPASS DY (2017)

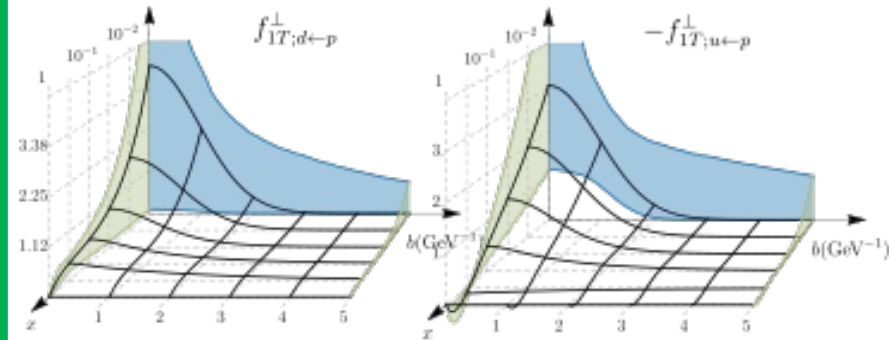

M. Bury, A. Prokudin, A. Vladimirov, JHEP_05_151 (2021)

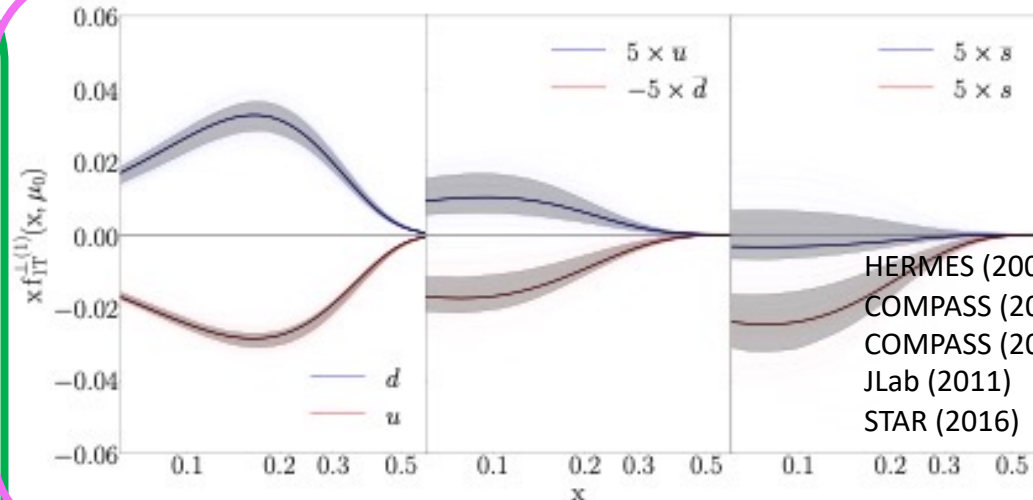

HERMES (2009)
COMPASS (2009)
COMPASS (2015)
JLab (2011)
STAR (2016)

M. Echevarria, Z. Kang, J. Terry_JHEP_01_126_(2021)

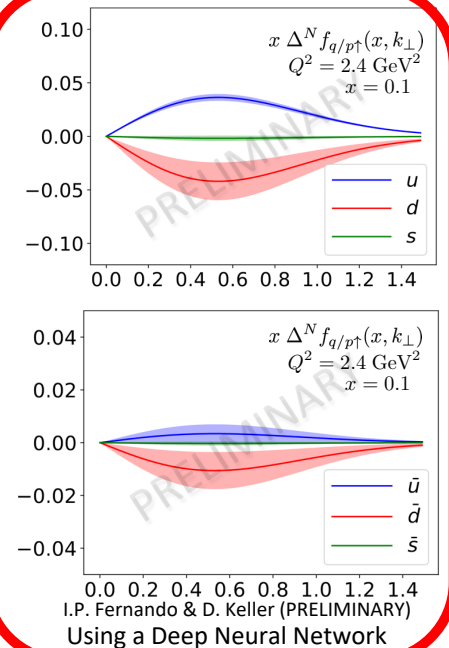

I.P. Fernando & D. Keller (PRELIMINARY)
Using a Deep Neural Network

SpinQuest in the Global Context

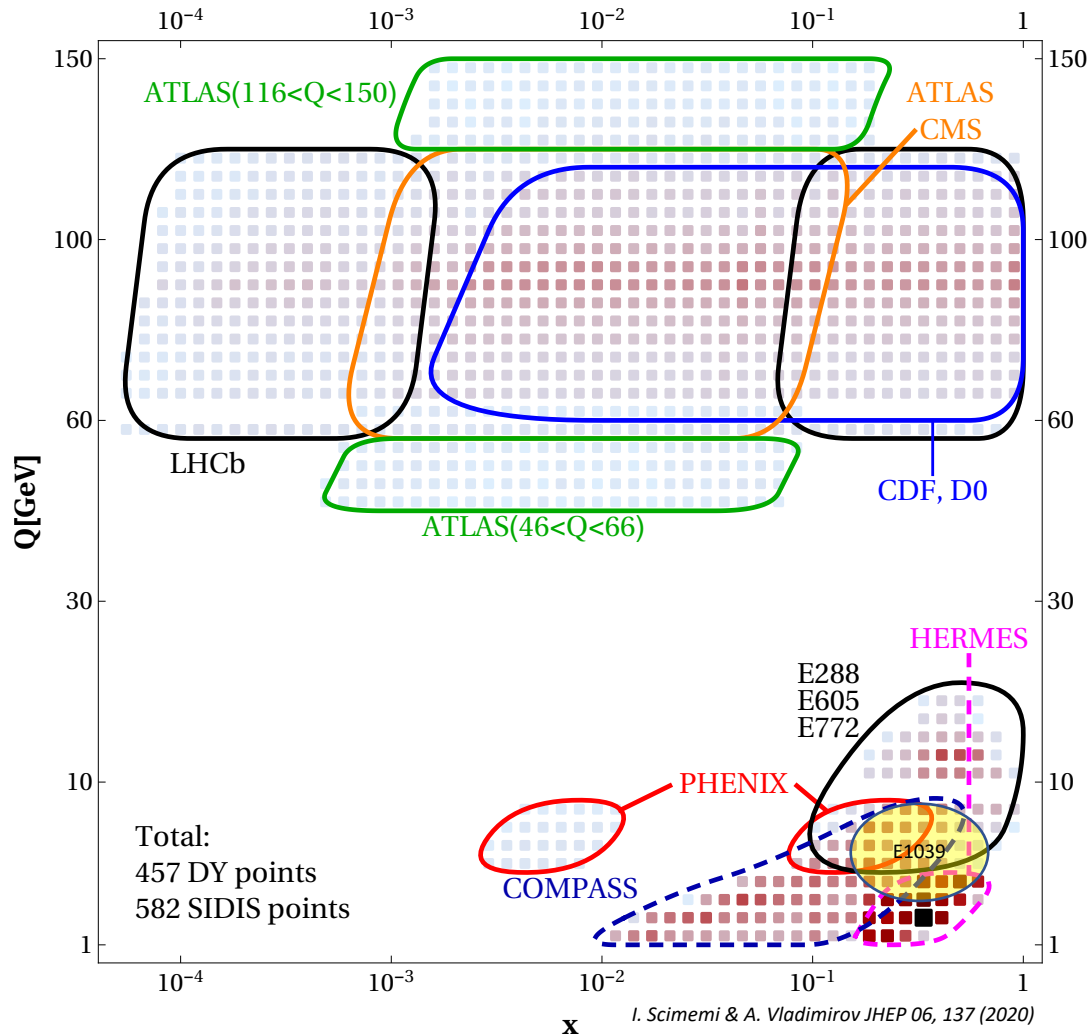

Drell-Yan measurements above the J/ψ peak fall in a unique region with Q^2 in the range of $16 < M^2 < 81$ GeV² and $Q_T < \text{few GeV}$

In terms of Q^2 , P_T , x_{target} and the process (DY) E1039 has a unique kinematics setting for the sea quarks

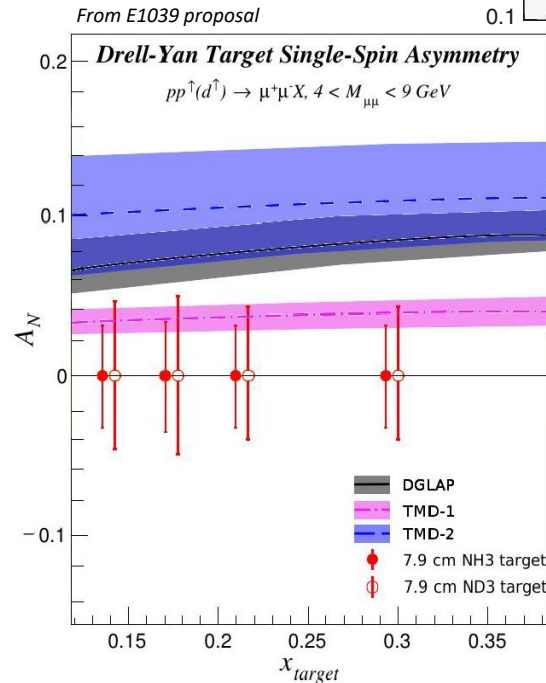
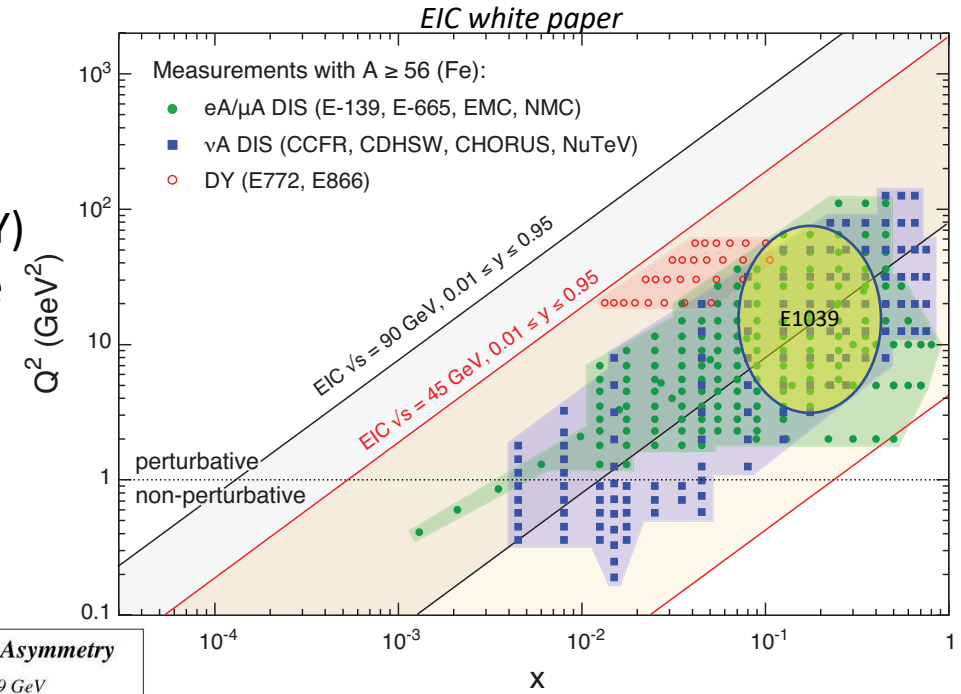

- The E1039 experiment focuses unique kinematics to extract **sea** quark Sivvers function in DY
- ←Plot: Uncertainties in the predicted Sivvers asymmetry in polarized Drell-Yan process from SpinQuest.

DGLAP: M. Anselmino et al arXiv:1612.06413
TMD-1: M. G. Echevarria et al arXiv:1401.5078
TMD-2: P. Sun and F. Yuan arXiv:1308.5003

Sea-quarks Sivers functions

- Initial attempts to measure the Sivers asymmetry for sea quark Sivers have been reported by the STAR collaboration at RHIC using W/Z boson production. Their data is statistically limited and favor a sign-change only if TMD evolutions effects are significantly smaller than expected.
- Lack of experimental data for smaller x to extract the sea quarks' Sivers functions.
 - * Various types of assumptions/treatment (flavor-independent and flavor-dependent)
 - * Uncertainties through global fitting became large relative to the 'valence' quarks.
- SpinQuest will perform the first measurement of the Sivers asymmetry in Drell-Yan proton-proton scattering (clean probe compared to the SIDIS process because there is no fragmentation associated with the process) from the sea quarks.

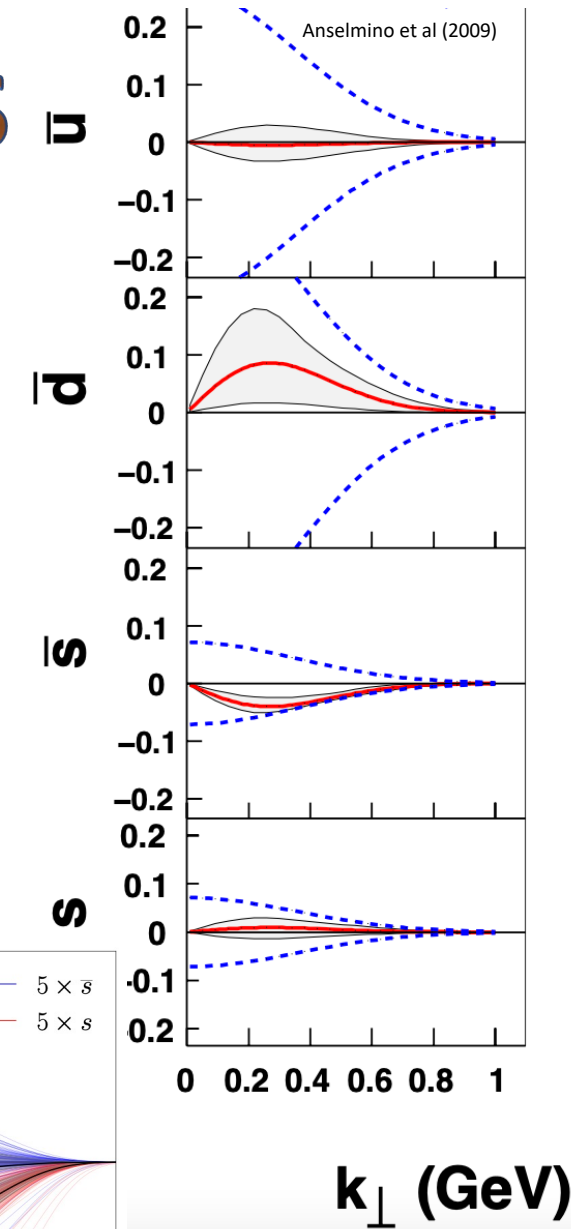
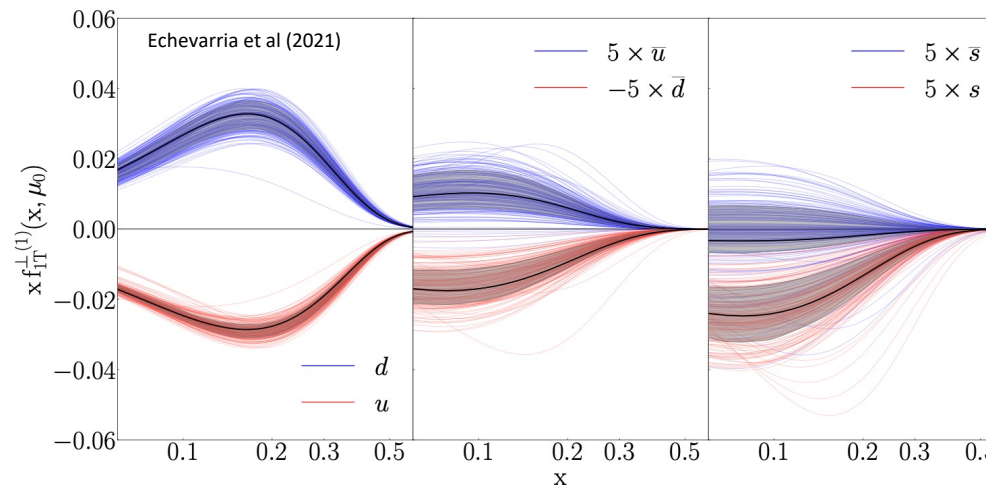

Polarized fixed target Drell-Yan : Sensitivity to sea-quarks

beam: valence quarks
at high x

target: sea quarks at
low/intermediate x

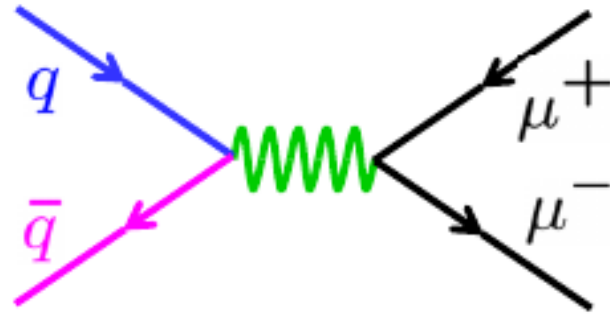

Sea-quarks
dominance

$$\frac{d^2\sigma}{dx_b dx_t} = \frac{4\pi\alpha^2}{x_b x_t S} \sum_{q \in \{u, d, s, \dots\}} e_q^2 [\bar{q}_t(x_t) q_b(x_b) + \cancel{q_t(x_t) \bar{q}_b(x_b)}]$$

u-quark dominance
(2/3)² vs. (1/3)²

acceptance limited
(Fixed Target, Hadron Beam)

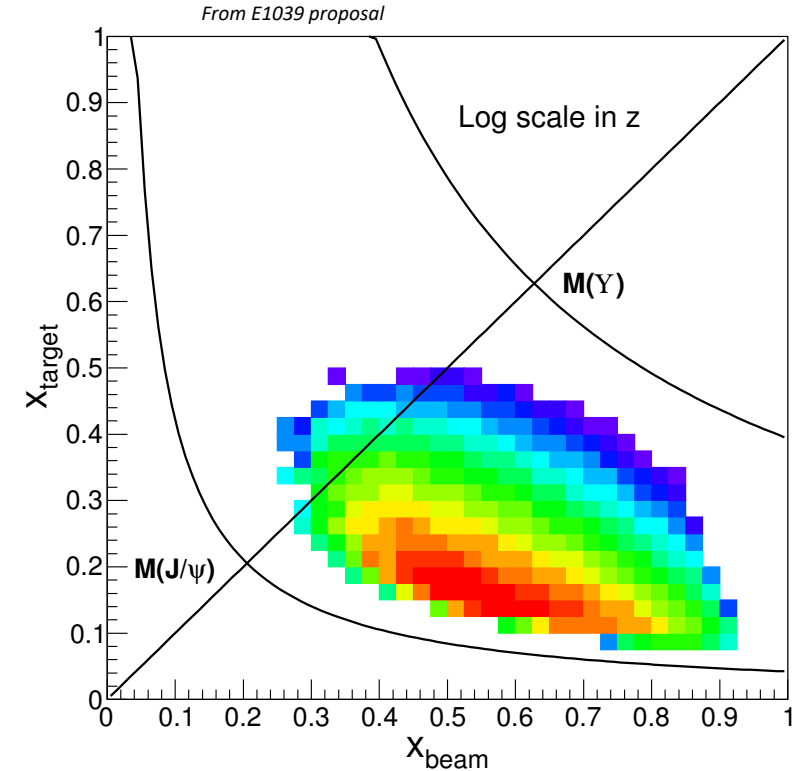

Valence-quarks
dominance

Polarized fixed target DY & J/ψ @ SpinQuest / E1039 experiment

$$A = \frac{\sigma(p_b^{un} p_t^{\uparrow}) - \sigma(p_b^{un} p_t^{\downarrow})}{\sigma(p_b^{un} p_t^{\uparrow}) + \sigma(p_b^{un} p_t^{\downarrow})}$$

Measurement:

The amplitude of the azimuthal angular modulation of the outgoing particles' (di-muons) scattering cross section with respect to the transverse spin direction of the polarized proton.

Drell-Yan $\sigma(p + p^{\uparrow(\downarrow)} \rightarrow \gamma + X)$

$$f_{q/p^{\uparrow}}(x, \mathbf{k}_T, \mathbf{S}_T; Q) = f_{q/p}(x, \mathbf{k}_T; Q) + \frac{1}{2} \Delta^N f_{q/p^{\uparrow}}(x, \mathbf{k}_T, \mathbf{S}_T; Q)$$

J/ψ $\sigma(p + p^{\uparrow(\downarrow)} \rightarrow J/\psi + X)$

$$f_{g/p^{\uparrow}}(x, \mathbf{k}_T, \mathbf{S}_T; Q) = f_{g/p}(x, \mathbf{k}_T; Q) + \frac{1}{2} \Delta^N f_{g/p^{\uparrow}}(x, \mathbf{k}_T, \mathbf{S}_T; Q)$$

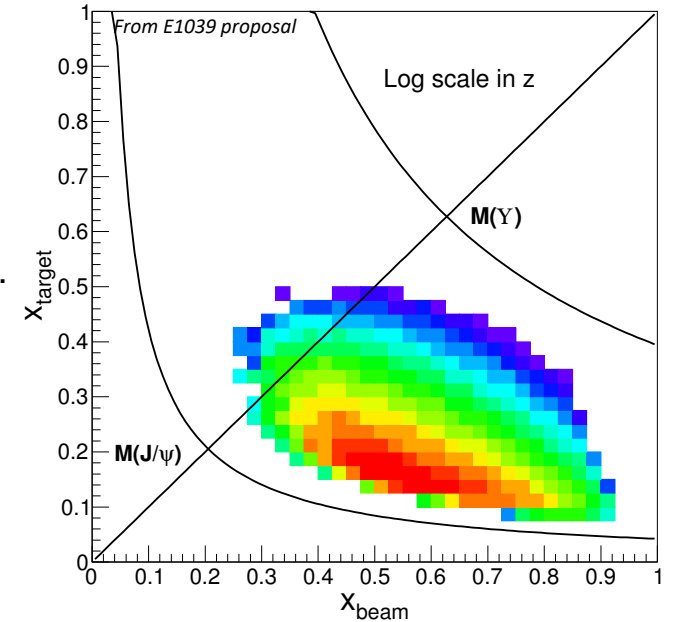

- SpinQuest will be able to explore a new region of kinematics for J/ψ compare to the PHENIX measurements
- J/ψ production:
 - PHENIX $\rightarrow gg$ fusion at $\sqrt{s} = 200$ GeV
 - SpinQuest $\rightarrow q\bar{q}$ annihilation at $\sqrt{s} = 15.5$ GeV

About SpinQuest/E1039 Collaboration

<https://spinquest.fnal.gov>

INSTITUTIONS 20

- 1) [Abilene Christian University](#)
- 2) [Argonne National Laboratory](#)
- 3) [Aligarh Muslim University](#)
- 4) [Boston University](#)
- 5) [Fermi National Accelerator Laboratory](#)
- 6) [KEK](#)
- 7) [Los Alamos National Laboratory](#)
- 8) [Mississippi State University](#)
- 9) [New Mexico State University](#)
- 10) [RIKEN](#)
- 11) [Shandong University](#)
- 12) [Tokyo Institute of Technology](#)
- 13) [University of Colombo](#)
- 14) [University of Illinois, Urbana-Champaign](#)
- 15) [University of Michigan](#)
- 16) [University of New Hampshire](#)
- 17) [Tsinghua University](#)
- 18) [University of Virginia](#)
- 19) [Yamagata University](#)
- 20) [Yerevan Physics Institute](#)

FULL MEMBERS 48 Postdocs 6 Grad. Students 12

Donald Isenhower (PI), Michael Daugherty, Shon Watson

Paul Reimer (PI), Donald Geesaman

Huma Haider (PI)

David Sperka (PI), Zijie Wan

Richard Tesarek (PI)

Shin'ya Sawada (PI)

Kun Liu (SP), Ming Liu, Kei Nagai

Lamiaa El Fassi (PI), Eric Fuchey

Stephen Pate (PI), Vassili Papavassiliou, Abinash Pun, Forhad Hossain, Dinupa Nawarathne, Harhsa Sirilal

Yuji Goto (PI)

Qinghua Xu (PI), Zhaohuizi Ji

Toshi-Aki Shibata (PI)

Hansika Atapattu (PI), Vibodha Bandara

Jen-Chieh Peng (PI), Ching Him Leung

Wolfgang Lorenzon (PI), Levgen Lavrukhin, Noah Wuerfel

Karl Slifer (PI)

Zhihong Ye (PI)

Dustin Keller (SP), Kenichi Nakano, Ishara Fernando, Zulkaida Akbar, Waqar Ahmed, Liliet Diaz, Anchit Arora, Arthur Conover, Jay Roberts

Yoshiyuki Miyachi (PI), Norihito Doshita

Hrachya Marukyan (PI)

AFFILIATE MEMBERS

Roy Salinas, Rusty Towell, Shannon McNease, Yves Ngenzi, Thomas Fitch

Kevin Bailey, Thomas O'Connor

Carol Johnstone, Charles Brown, Nhan Tran

Shigeru Ishimoto

Jan Boissevain, Patrick McGaughey, Andi Klein

Dipangkar Dutta

Naomi Makins, Daniel Jumper, Jason Dove, Mingyan Tian, Bryan Dannowitz, Randall McClellan, Shivangi Prasad

Daniel Morton, Richard Raymond, Marshall Scott

Maurik Holtrop

Donal Day, Donald Crabb, Oscar Rondon

Takahiro Iwata, Norihiro Doshita

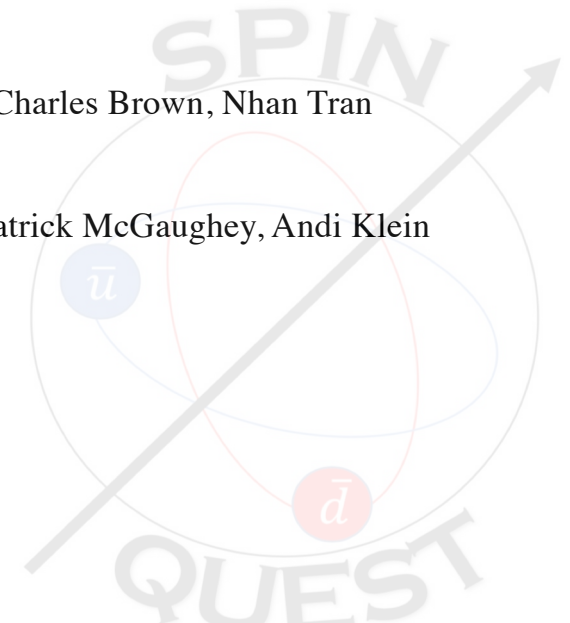

Fermilab proton beam main injector

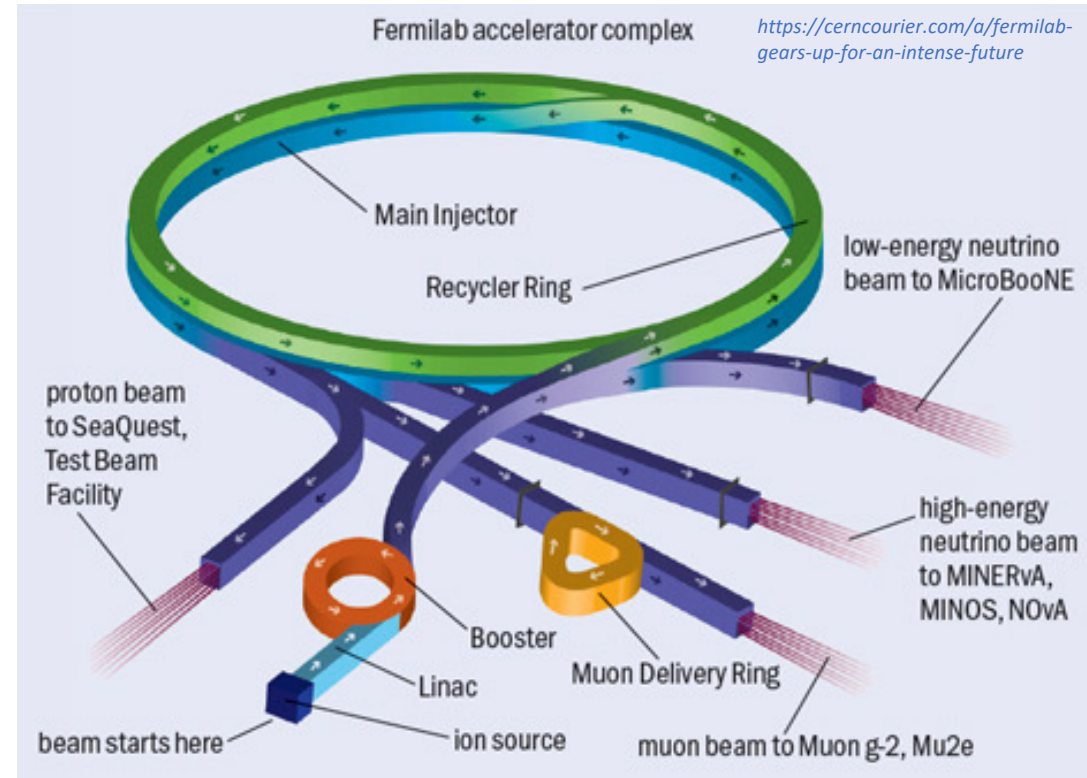
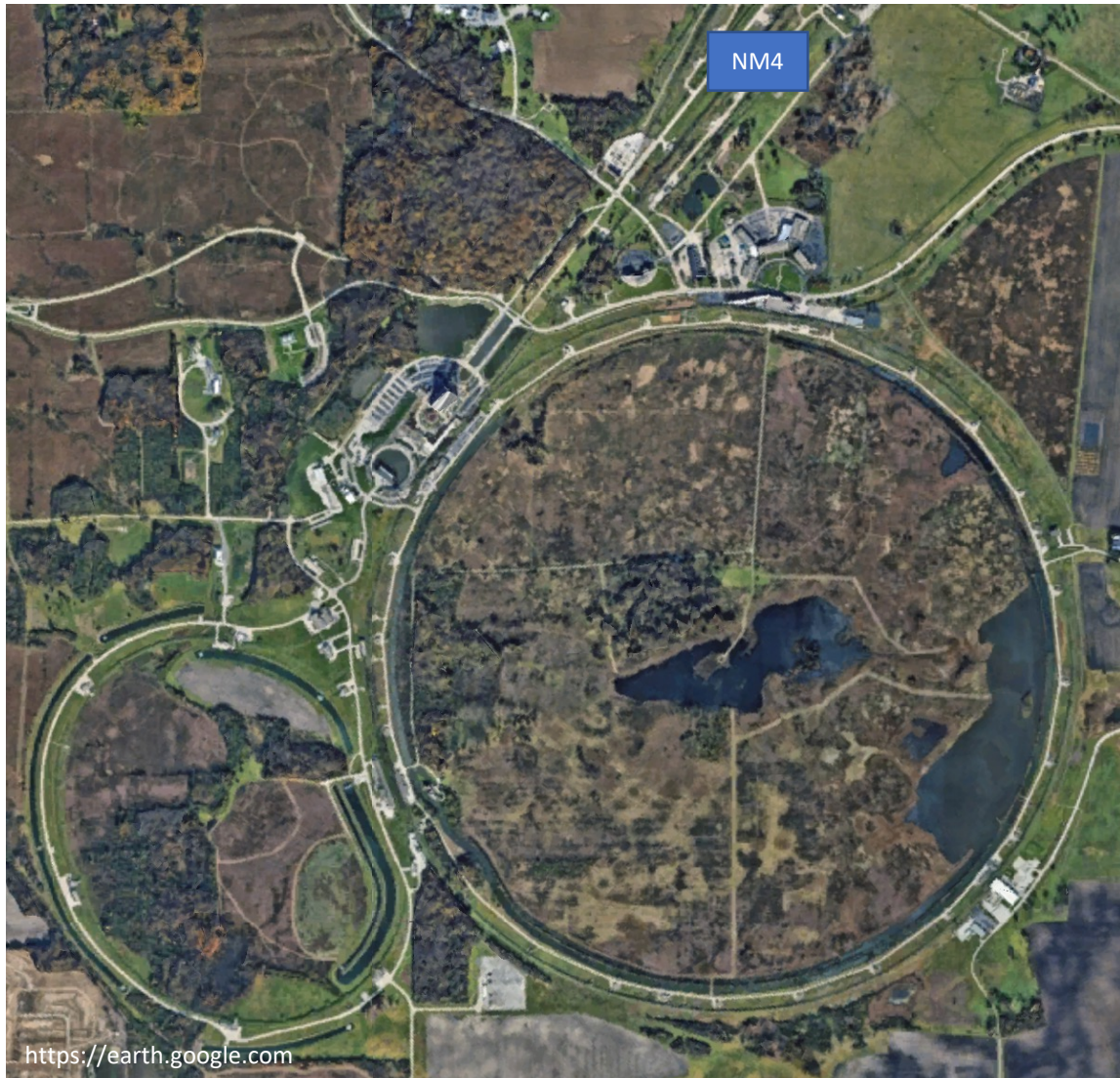

- 120 GeV/c proton beam
- $\sqrt{s} = 15.5$ GeV
- Projected beam
 - ❖ 5×10^{12} protons/spill Where $spill \approx 4.4$ s/min
 - ❖ Bunches of 1ns with 19ns intervals ~ 53 MHz
 - ❖ 7×10^{17} protons/year on target!

Fermilab proton beam main injector

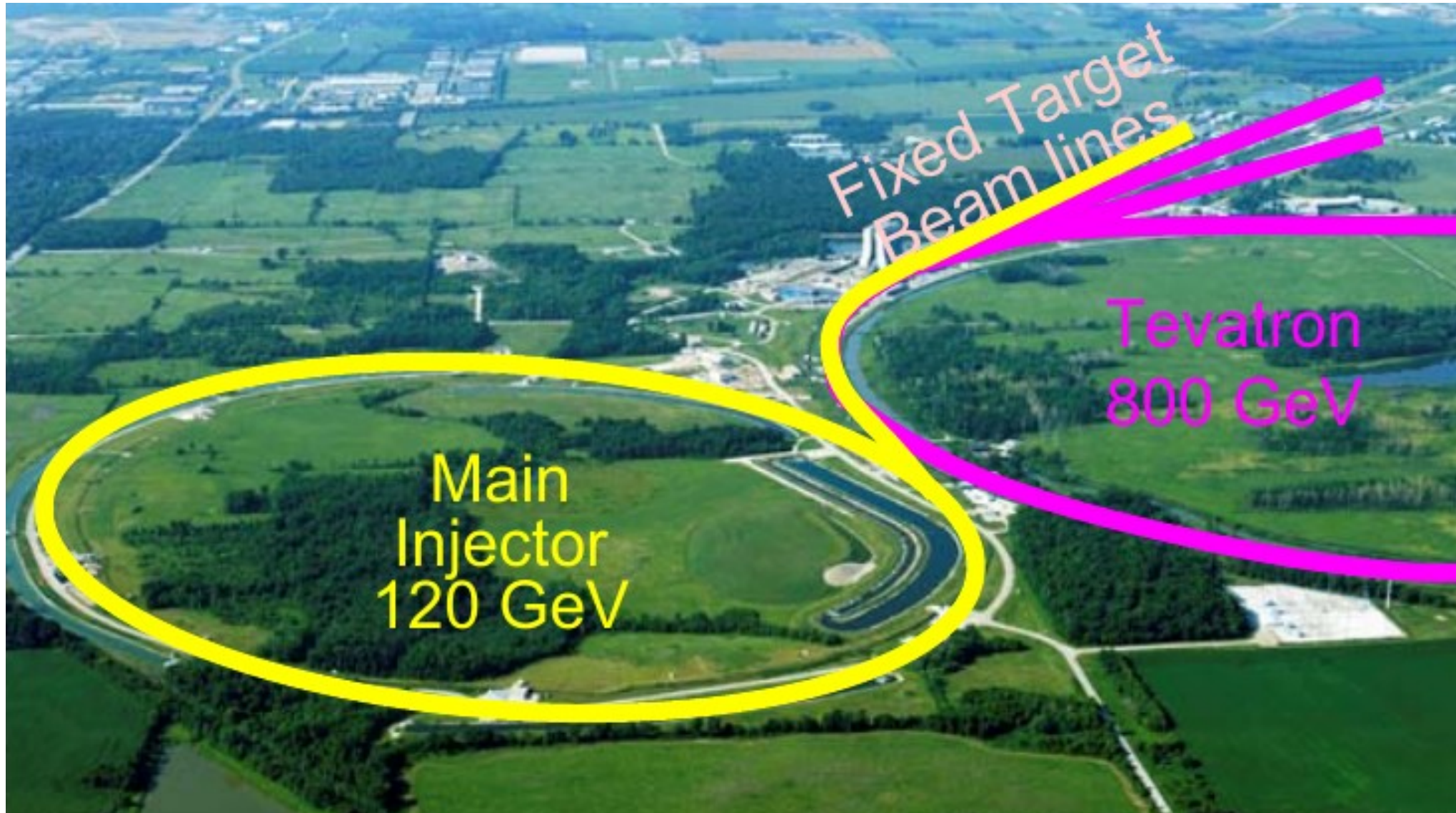

SpinQuest / E1039 Experiment Setup

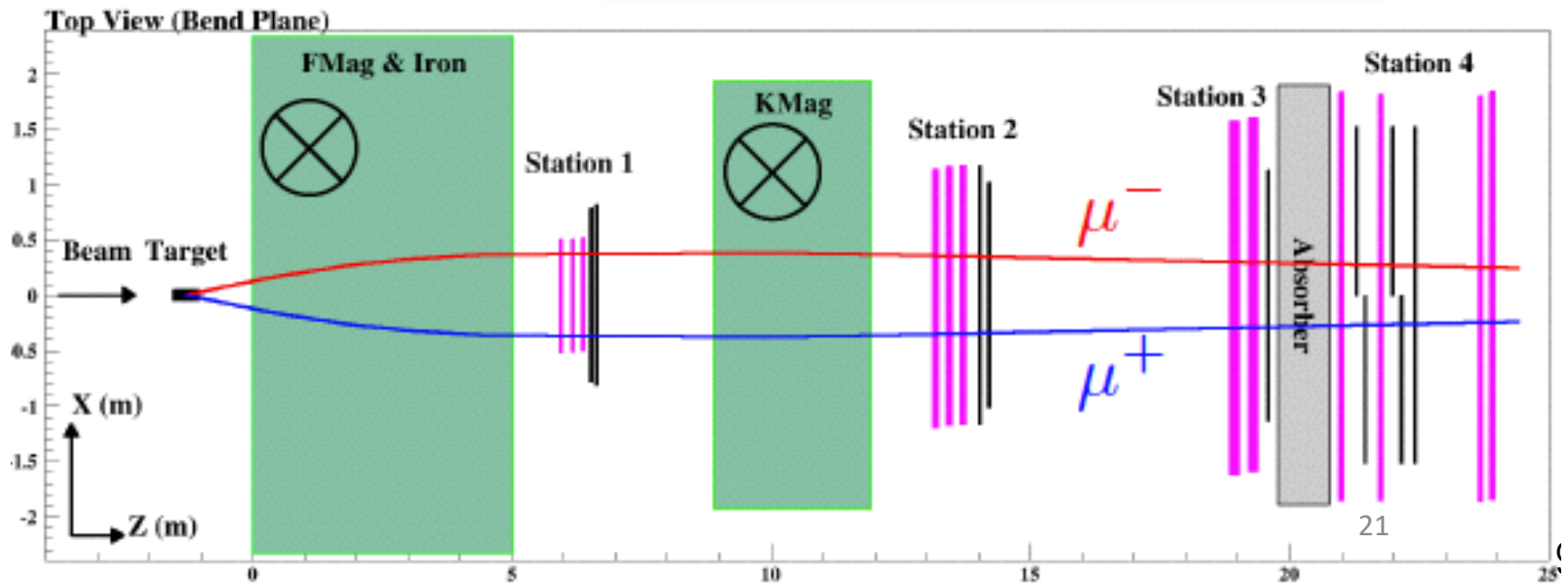
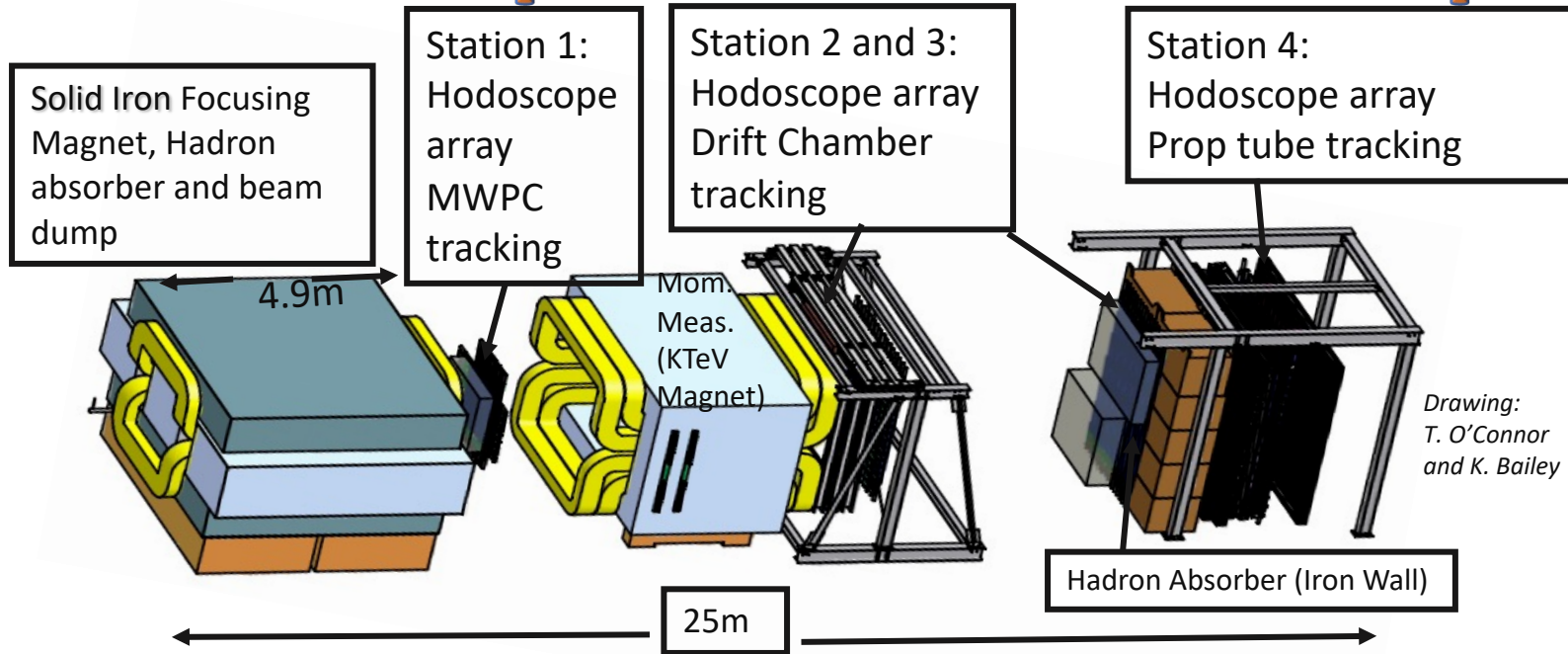
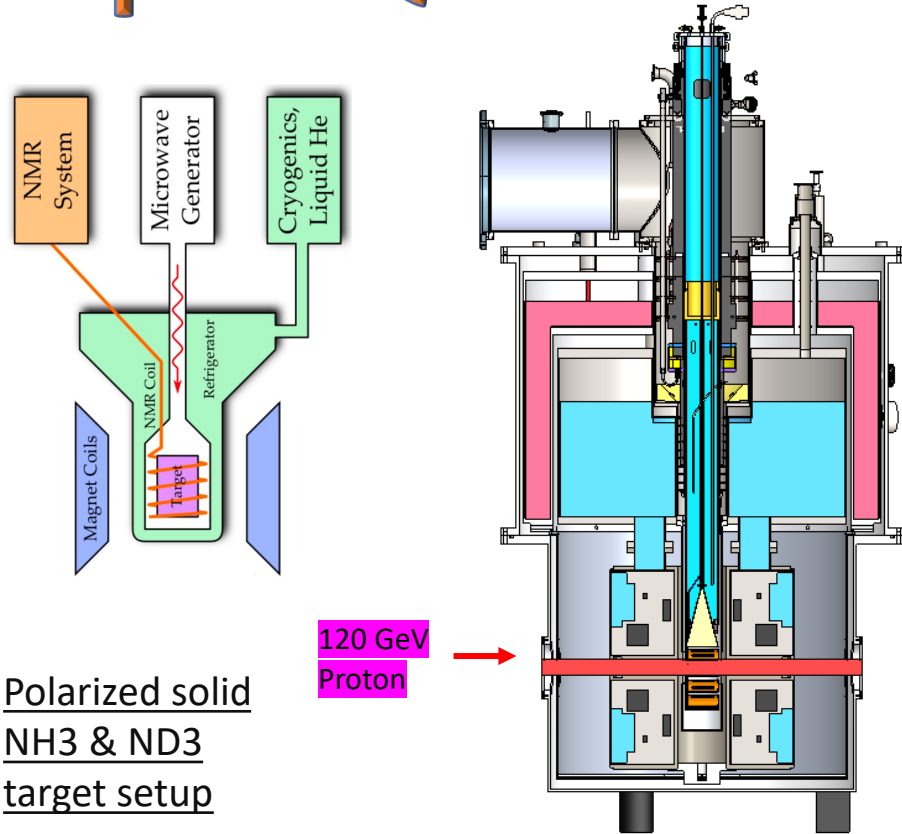

- ❖ Designed for high intensity proton beam (5×10^{12} protons/spill with 4.4s spill)
- ❖ 8 cm long solid NH₃ and ND₃ target cells
- ❖ Magnetic Field: $B = 5$ T with uniformity $dB/B < 10^{-4}$ over 8 cm
- ❖ ⁴He evaporation refrigerator (3 W of maximum cooling power) keeping the target at 1.1 K.
- ❖ 140 GHz microwave source (with DNP technique)
- ❖ Helium Liquefier System (200 L/day) for sustainable cooling

SpinQuest / E1039 Experiment Setup

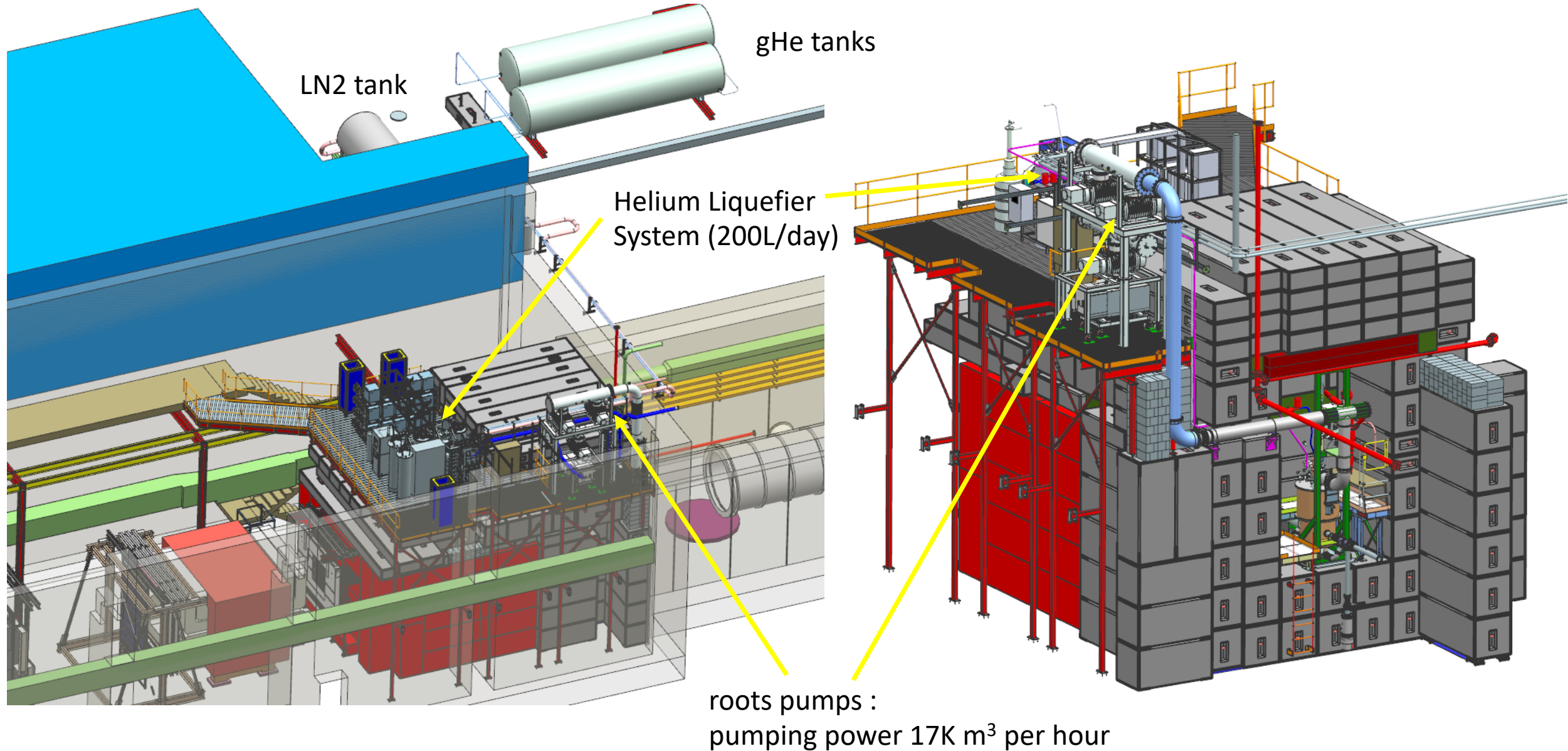

SpinQuest / E1039 Experiment Setup



From beam down-stream



Beam-window and superconducting magnet



From target cave to beam-upstream

Predicted Uncertainties

- Beam ($\sim 2.5\%$)
 - Relative luminosity
 - Drifts
 - Scraping

- Analysis sources ($< 3.5\%$)
 - Tracking efficiency
 - Trigger & geometrical acceptance
 - Mixed background
 - Shape of DY

- Target ($< 6\%$)
 - TE calibration
 - Polarization inhomogeneity
 - Density of target ($\text{NH}_3(s)$)
 - Uneven radiation damage
 - Beam-Target misalignment
 - Packing fraction
 - Dilution factor

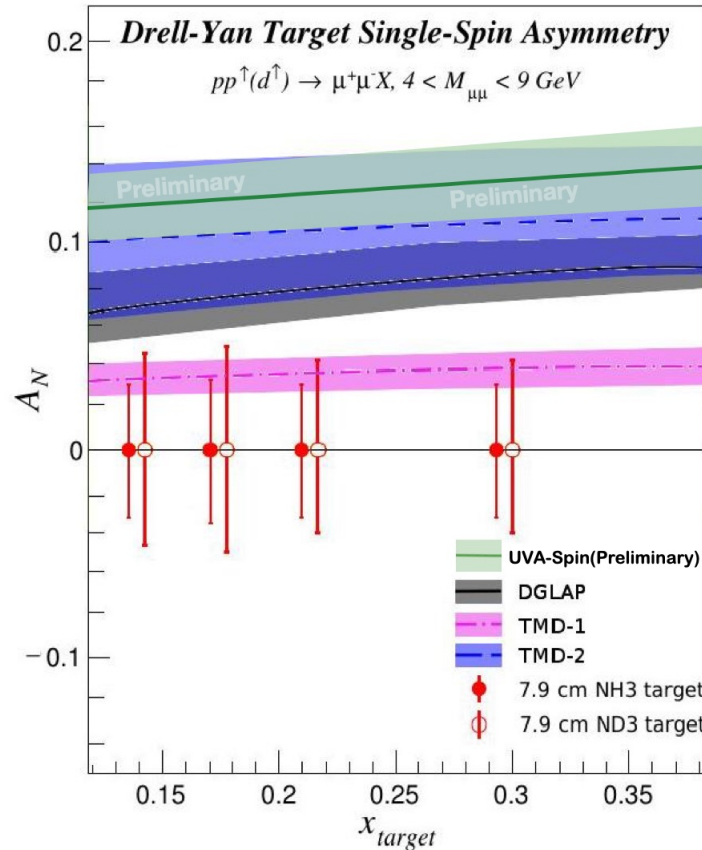

DGLAP: M. Anselmino et al arXiv:1612.06413
 TMD-1: M. G. Echevarria et al arXiv:1401.5078
 TMD-2: P. Sun and F. Yuan arXiv:1308.5003
 A. Prokudin et al (in progress)
 I. Fernando, D. Keller (Preliminary)

$$A = \frac{2}{f|S_T|} \frac{\int d\phi_S d\phi \frac{dN(x_b, x_t, \phi_S, \phi)}{d\phi_S d\phi} \sin(\phi_S)}{N(x_b, x_t)}$$

x_2 bin	$\langle x_2 \rangle$	$\text{NH}_3 (p \uparrow)$		$\text{ND}_3 (d \uparrow)$	
		N	ΔA (%)	N	ΔA (%)
0.10 - 0.16	0.139	5.0×10^4	3.2	5.8×10^4	4.3
0.16 - 0.19	0.175	4.5×10^4	3.3	5.2×10^4	4.6
0.19 - 0.24	0.213	5.7×10^4	2.9	6.6×10^4	4.1
0.24 - 0.60	0.295	5.5×10^4	3.0	6.4×10^4	4.1

Material	Density	Dilution factor	Packing fraction	Polarization	Interaction length
NH_3	0.867 g/cm^3	0.176	0.60	80%	5.3%
ND_3	1.007 g/cm^3	0.300	0.60	32%	5.7%

Goodness of event-reconstruction from E906

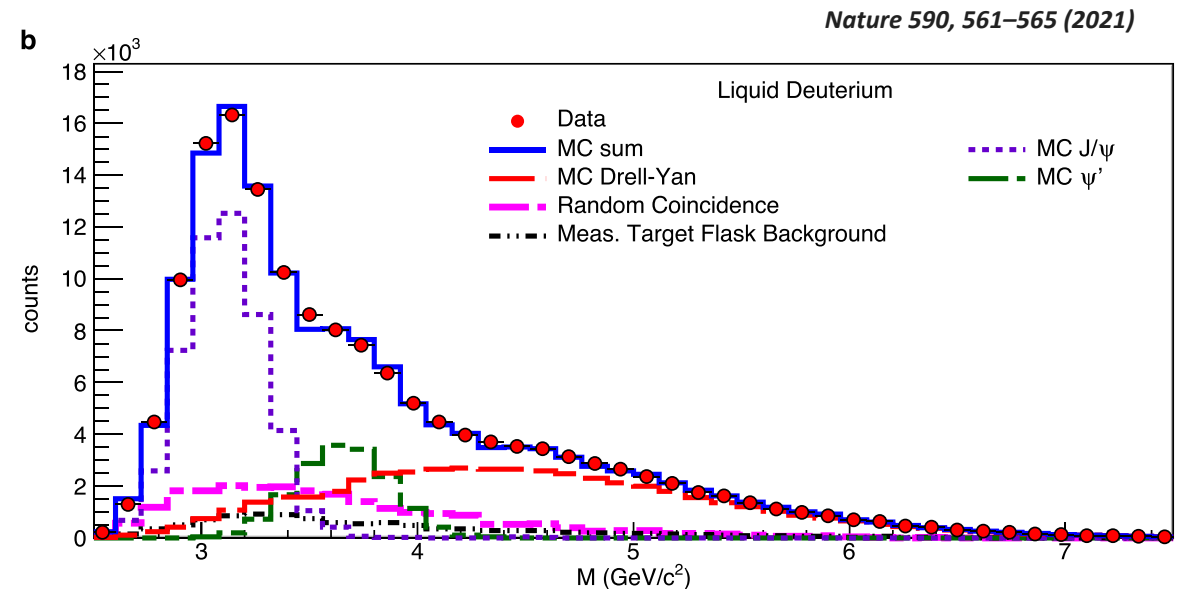
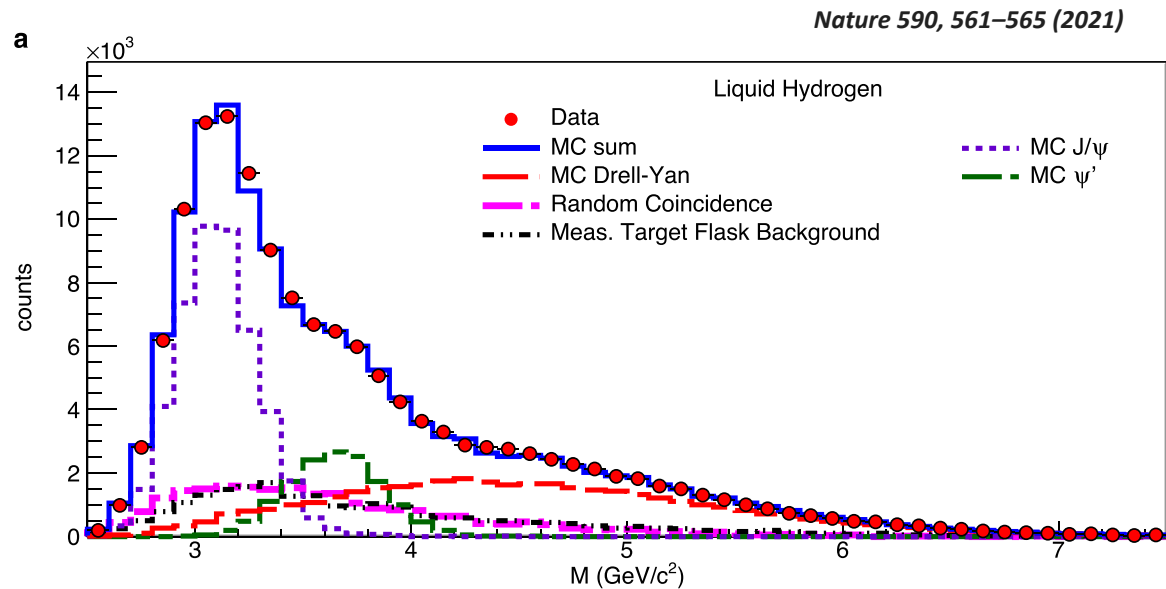

- Monte-Carlo describe data well
- Better resolution than expected

- $\delta\sigma_M(J/\psi) \sim 220 \text{ MeV}$
- $\delta\sigma_M(DY) \sim$ truth-reconstructed from event-by-event MC
- J/ψ and ψ' separation

The projected event selection/reconstruction is expected to be the same for E1039

SpinQuest / E1039 Timeline

- 2018, March: DOE approval
- 2018, May: Fermilab stage-2 approval
- 2018, June: E906 decommissioned
- 2019, May: Transferred the polarized target from UVA to Fermilab
- **Now**: commission all components using cosmic rays,
Target Cooldown Commissioning
- Polarized target commissioning will be completed by January 2023
- E1039 first beam commissioning starts in January 2023
[Run for 2+ years, 2023-2025+]

SpinQuest / E1039 Goals

- SpinQuest will perform the first measurement of the Sivers asymmetry in Drell-Yan proton-proton scattering from the sea quarks (\bar{u} & \bar{d}) with sign.

$$f_{1T}^\perp|_{\text{SIDIS}} = - f_{1T}^\perp|_{\text{DY}}$$

A direct QCD prediction is a Sivers effect in the Drell-Yan process that has the opposite sign compared to the one in semi-inclusive DIS.

- Measurement of Sivers function for gluons (J/psi TSSA)
- Explore a unique range of virtualities and transverse momenta not accessible through Z^0/W^\pm measurements
- Extensions: transversity, tensor charge, tensor polarized observables, dark sector, polarized proton beam,...

Future: Transverse Structure of Spin-1 target with DY

<https://arxiv.org/abs/2205.01249>

<https://doi.org/10.1016/j.nima.2020.164504>

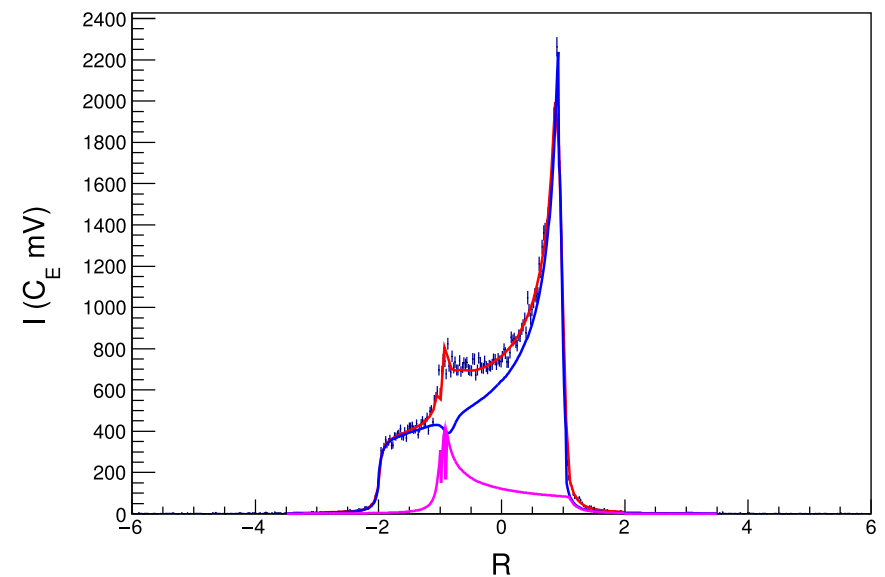
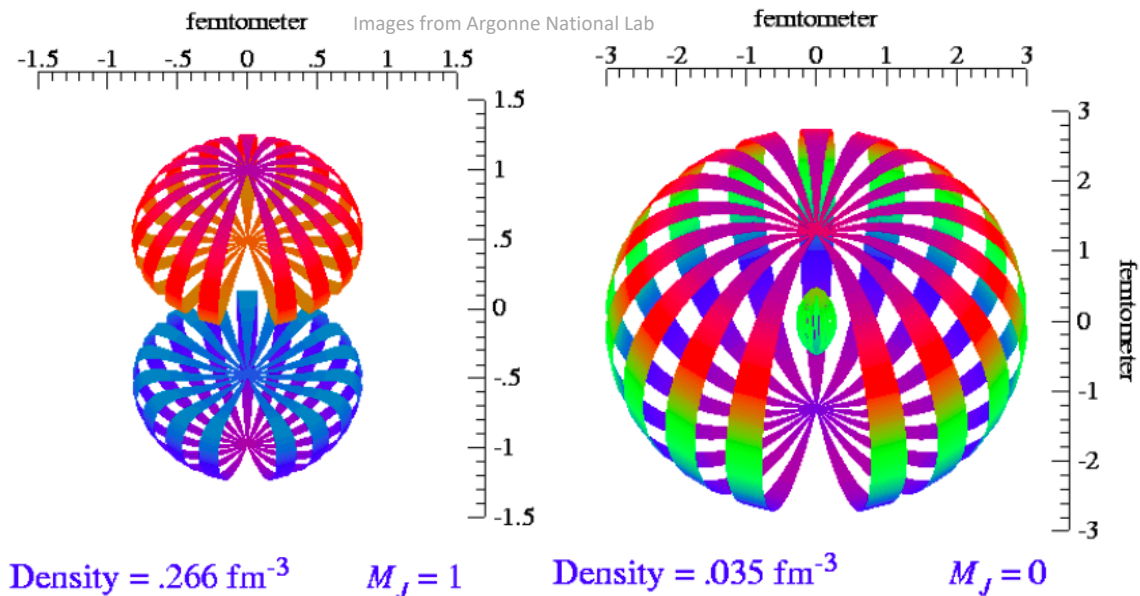

Graphical representation of the shape of the deuteron for two specified equidensity surfaces

- Deuteron is a Spin-1 has two polarization profiles: Vector Polarization and Tensor Polarization
- Transversely vector polarized Deuteron target at SpinQuest, facilitate access to the sea-quark transversity

$$A_{UT}^{\sin(\varphi_{cs} + \varphi_s) \frac{q_T}{M_N}} \Big|_{pD^\uparrow \rightarrow l+l^- X} \simeq - \frac{\left[4h_{1u}^{\perp(1)}(x_p) + h_{1d}^{\perp(1)}(x_p) \right] \left[\bar{h}_{1u}(x_{D^\uparrow}) + \bar{h}_{1d}(x_{D^\uparrow}) \right]}{\left[4f_{1u}(x_p) + f_{1d}(x_p) \right] \left[\bar{f}_{1u}(x_{D^\uparrow}) + \bar{f}_{1d}(x_{D^\uparrow}) \right]}$$

BM from unpolarized-DY (E906)

- Transversely Tensor polarized Deuteron → Tensor structure of the Deuteron, gluon transversity and clean \bar{d} transversity from $m = \pm 1$ states

Welcome!

Please Join The Effort

Dustin Keller [UVA] (dustin@virginia.edu)[Spokesperson]

Kun Liu [LANL] (liuk.pku@gmail.com) ([Spokesperson])

<https://spinqest.fnal.gov/>

<http://twist.phys.virginia.edu/E1039/>

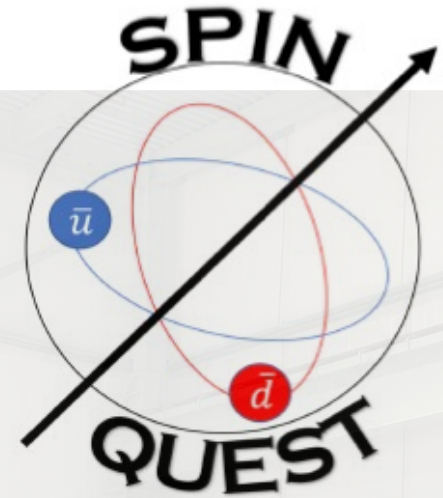

 **Fermilab**

Thank you

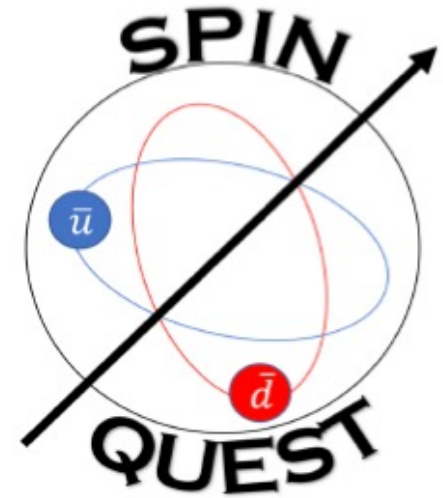

UNIVERSITY
of
VIRGINIA



U.S. DEPARTMENT OF
ENERGY

Office of
Science

This work is supported by DOE contract DE-FG02-96ER40950