

**Operation Readiness Clearance (ORC)
of
SpinQuest (E1039) UVA-NMR
Part 2 (Commercial Components)**

ORC - ####

Dustin Keller, Ishara Fernando & Waqar Ahmed

Table of Contents

1. Components and Power Budget of the UVA-NMR system.....	(1)
2. National Instruments Components.....	(3)
2.1 BNC 2090.....	(3)
2.2 BNC 2115.....	(4)
2.3 SCB-68A.....	(5)
2.4 NI PXIe-1071.....	(6)
3. RF generator (Rhode & Schwartz SMT 06).....	(7)
4. Oscilloscope (Tektronix TDS 3032).....	(7)
5. Safety.....	(8)
<i>References</i>	(8)

1 Components and Power Budget of the UVA-NMR system

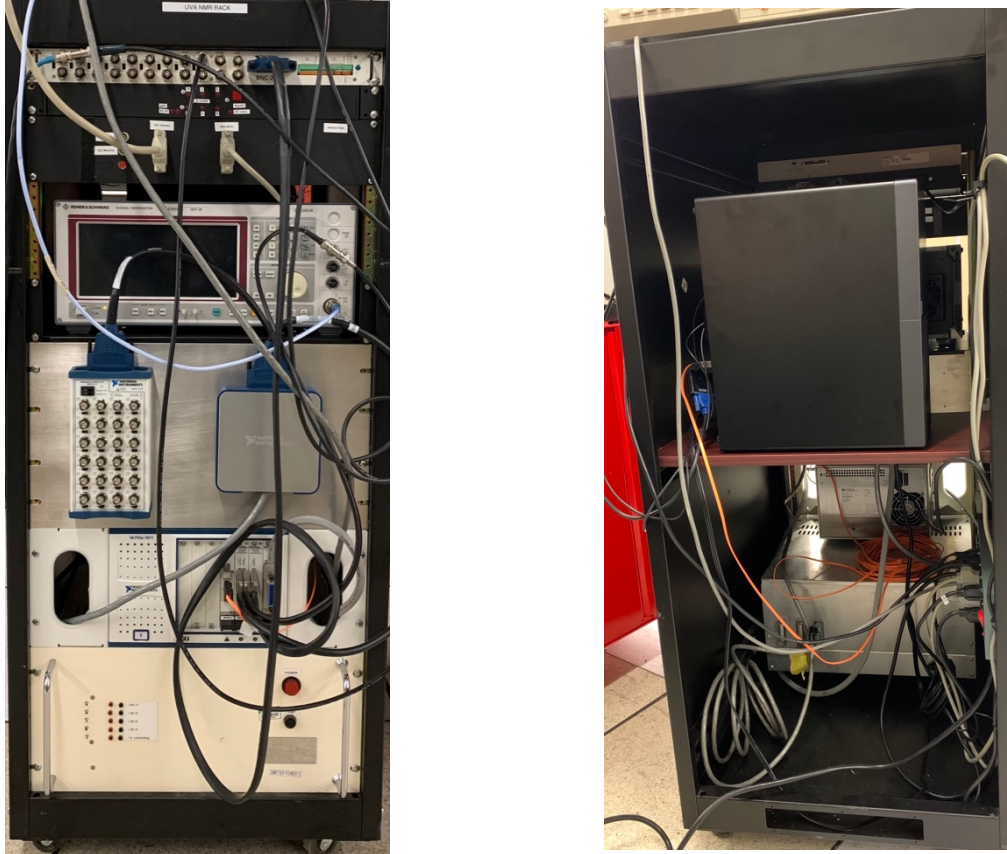

Figure 1.1: UVA-NMR System (front view (left), back view (right))

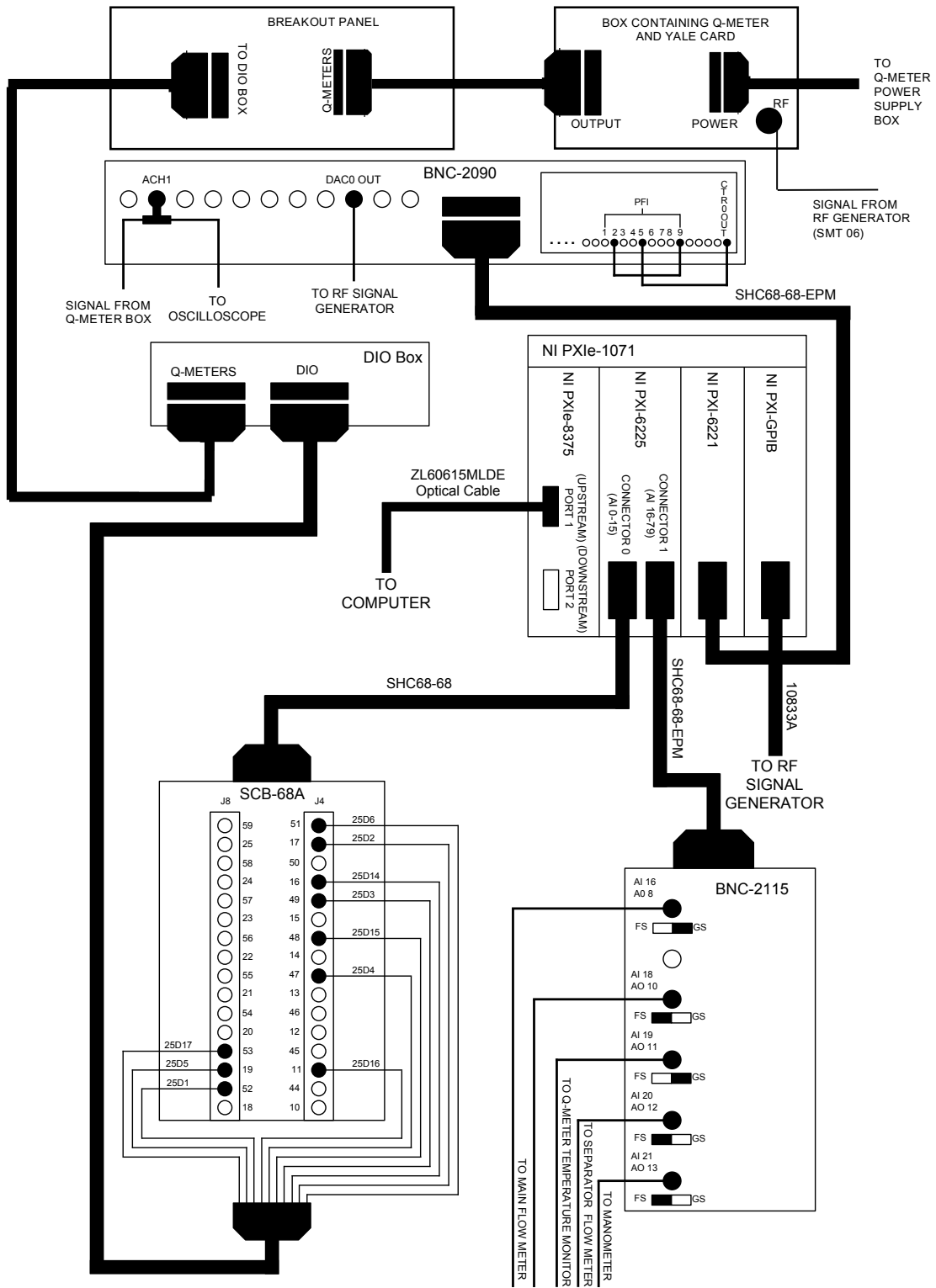

Figure 1.2: UVA-NMR system connections

Component	Voltage (V)	Current (A)	Power (W)
Q-meter and Yale-Card power supply	120	0.3	36.0
DAQ National Instruments (PXle)	120	4.2	504.0
Computer (Dell XPS)	120	4.0	460.0
RF generator (SMT 06)	120	2.7	324.0
Oscilloscope (Tektronics TDS 3032)	120	0.62	74.4
Total			1,398.4

Table 1.1: Power budget

2 National Instruments Components

The NMR rack contains four National Instruments components. This hardware functions as a Data AcQuisition (DAQ) device and as an Analog-to-Digital Converter (ADC) for the analog signals. They also facilitate communication and control of the NMR system by the computer.

2.1 BNC 2090

The BNC-2090 is a BNC patch panel (see Fig. 2.1.1) that collects analog signals from the box and sends them to the NMR ADC [1].



Figure 2.1.1: BNC 2090 (upper: front panel, lower: back panel)

2.2 BNC 2115

The BNC-2115 is another BNC patch panel which accepts analog signals from the “slow control” devices used in conjunction with the NMR system (see left panel of Fig. 2.2.1). Such slow control devices include temperature sensors and flow meters, among others, which monitor conditions within the refrigerator during operation. The BNC-2115 passes these analog signals to the DAQ and ADC [2].



Figure 2.2.1: (left) BNC 2115, (right) SCB-668A

BNC-2115 Port #	Slow Control	Source
AI 16/AO 8	Main Flowmeter	GS
AI 17/AO 9	NC	N/A
AI 18/AO 10	UNKNOWN	FS
AI 19/AO 11	Q-Meter Temp. Monitor	GS
AI 20/AO 12	Sep. Flow Meter	FS
AI 21/AO 13	Manometer	FS
⋮	NC	N/A

Table 2.2.1: BNC 2115 ADC connections

2.3 SCB-68A

The SCB-68A box allows the computer to communicate with the DIO box [3]. This allows the user at the computer to adjust the Yale card gain, DC convert the system, and Select the Q-meter channel, right from the computer.

SCB-68A J8 Pin #	Cable Pin #	SCB-68A J4 Pin #	Cable Pin #
59	NC	51	25D6
25		17	25D2
58		50	NC
24		16	25D14
57		49	25D3
23		15	NC
56		48	25D15
22		14	NC
55		47	25D4
21		13	NC
54		46	
20		12	NC
53		45	
19		25D17	11
52	25D5	44	NC
18	25D1	10	
	NC		

Table 2.3.1: Connections from SCB-68A to DIO box (in the notation 25DX refers to the pin number “X” of a 25-pin D-sub connector).

2.4 NI-PXIE-1071



Figure 2.4.1: The PXI system (or the DAQ panel) of the UVA-NMR system

The PXI system (see Fig. 2.4.1) is a platform for PC-computer based measurement and automation systems. The NI PXIe-1071 Express Chassis is a box which manages the PXI system, providing power, cooling, and communication between the PXI modules it houses [4]. Our PXI system uses four modules:

- a) **NI PXI-6221**: This board is part of the NMR DAQ. It functions as the NMR ADC, or Analog-to-Digital Converter.
- b) **NI PXI-6225**: The PXI-6225 board is an Analog Input Multifunction DAQ. It is the “slow control” ADC, converting the analog signals from the slow control devices to digital signals and sending them to the computer. It also acts as an intermediary for computer control of the DIO box.
- c) **NI PXI-GPIB**: This board is a high performance IEEE488 controller module for the PXI system. It enables control of the RF signal generator by the computer.
- d) **NI PXIe-8375**: Through this PXI module, the LabVIEW based computer system can communicate with the PXIe-1071 chassis and modules, and controlling the PXI system.

3 RF Generator (Rhode & Schwarz SMT 06)

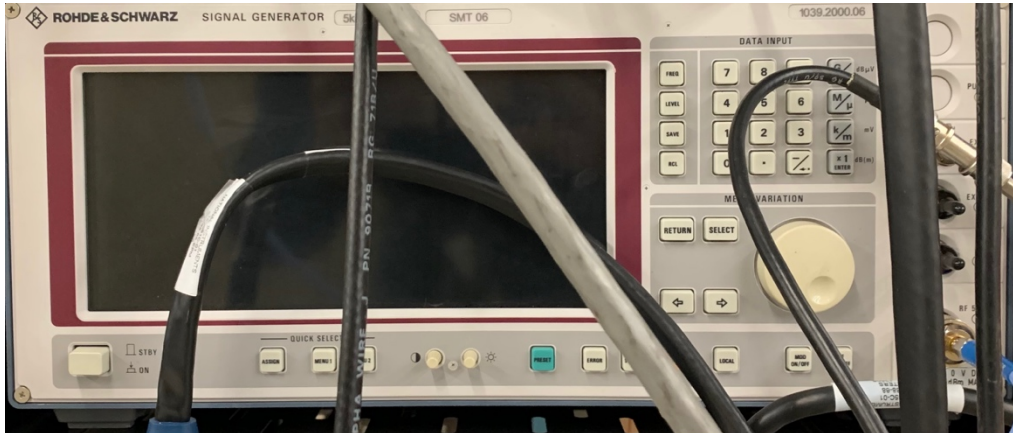

Figure 3.1: RF Generator Rohde & Schwarz SMT 06

The RF signal generator used is a Rohde & Schwarz SMT 06 model, which can provide RF signals from 5 kHz to 1.5 GHz. Please refer to the operations manual [5].

4 Oscilloscope (Tektronix TDS 3032)

The oscilloscope (see Ref. [6] for the manual), takes the input from “ACH1” and “DAC0 OUT” channels (see Figure 1.2) from Q-meter output (to CH1) and RF generator output (to CH2) accordingly to see the NMR signal.

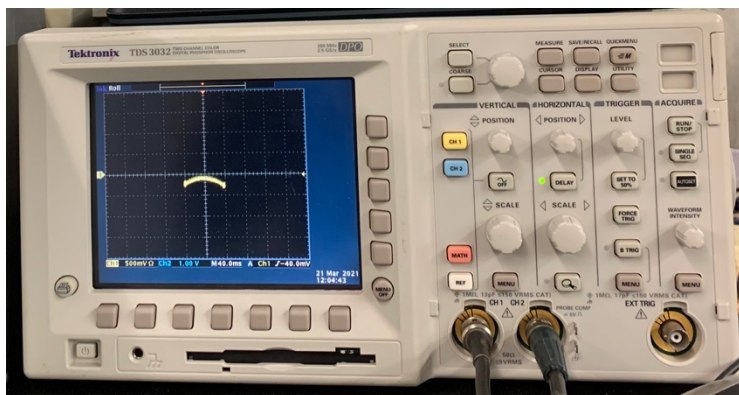

Figure 10: Oscilloscope Tektronix TDC 3032 (see Ref. [10])

5 Safety

Any component of this UVA-NMR system doesn't use high voltage or high current. RF signal generator is scanning only up to ~220 MHz. There is about nano-Watt level radiation will be exposed by the crystal that is used to tune the UVA-NMR system, and it is considerably small.

References

- [1] BNC-2090 manual
- [2] BNC-2115 manual
- [3] NI SCB-68A manual
- [4] NI PXIe-1071 manual
- [5] RF generator SMT 06 manual
- [6] Oscilloscope (Tektronix TDS 3032)