

# **Advances In Solid-Target Tensor Polarization**

**Conditional Review**

**D Keller**

# Contents

- Deuteron Polarization CW-NMR in Polycrystalline Samples
- The DNP process in Spin-1
- CW-NMR Measurement Theory in Nuclear Experiments
- Charge 1 (Enhancement Techniques)
  - Application of SS-RF (Specialized Hole Burning)
  - The three essential concepts for RF NMR line manipulation
- Charge 2 (Measurement and Error)
  - Simple and Accurate SS-RF CW-NMR Measurement
  - Software and Instrumentation
- Charge 3 (Changes as a function of Dose)
- Charge 4 (Experimental Situation)

# Deuteron Polarization

## CW-NMR in Polycrystalline Samples

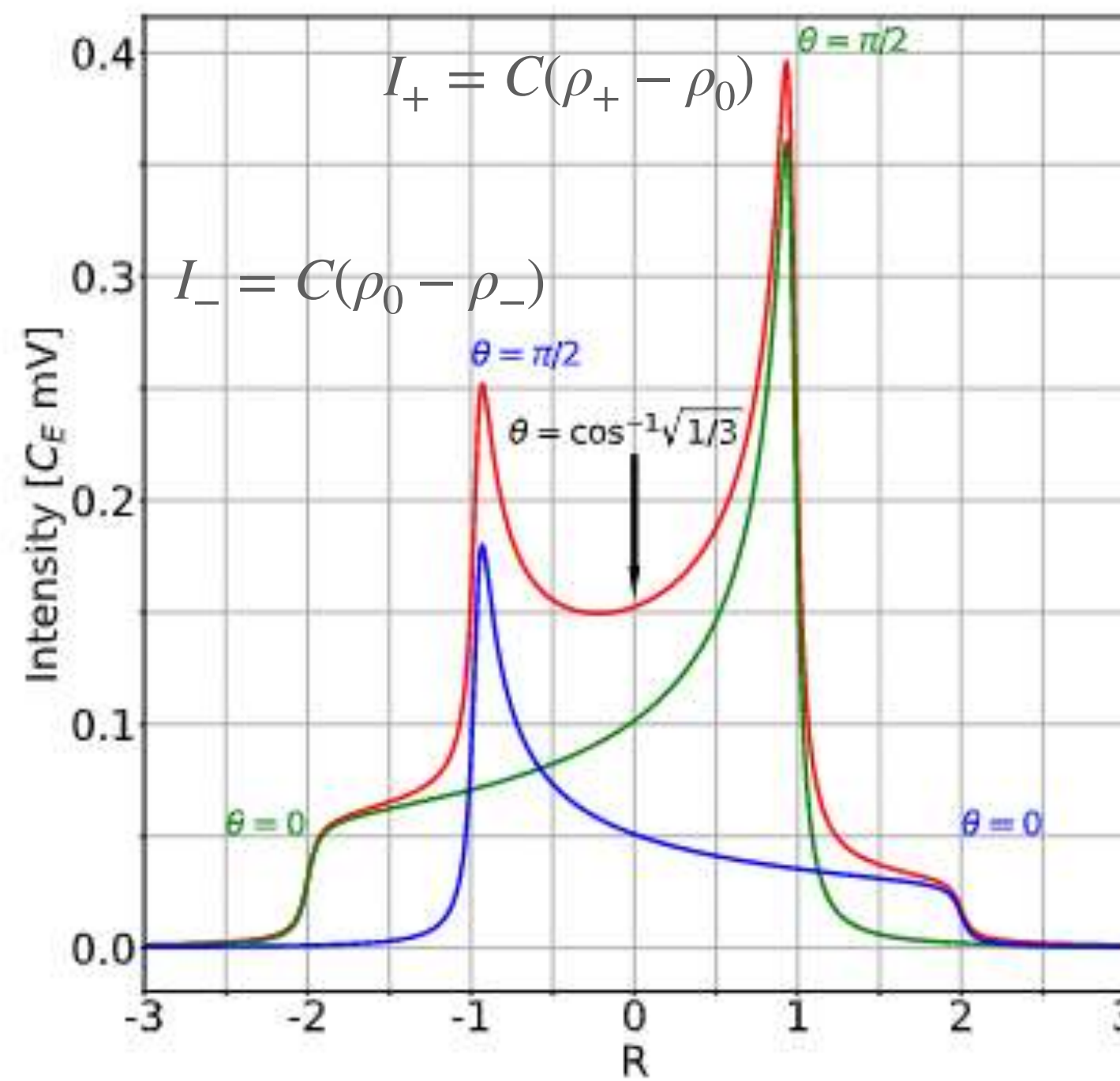

$$P = \frac{\rho_+ - \rho_-}{\rho_+ + \rho_0 - \rho_-}$$

$$Q = \frac{\rho_+ + \rho_- - 2\rho_0}{\rho_+ + \rho_0 - \rho_-}$$

$$R = \frac{\omega - \omega_d}{3\omega_q}$$

$$\mathcal{F} = \frac{1}{2\pi\mathcal{X}} \left[ 2\cos(\alpha/2) \left( \arctan \left( \frac{\mathcal{Y}^2 - \mathcal{X}^2}{2\mathcal{Y}\mathcal{X}\sin(\alpha/2)} \right) + \frac{\pi}{2} \right) + \sin(\alpha/2) \ln \left( \frac{\mathcal{Y}^2 + \mathcal{X}^2 + 2\mathcal{Y}\mathcal{X}\cos(\alpha/2)}{\mathcal{Y}^2 + \mathcal{X}^2 - 2\mathcal{Y}\mathcal{X}\cos(\alpha/2)} \right) \right],$$

Fit areas instead!!

$$E_m = -\hbar\omega_d m + \hbar\omega_q \{ 3\cos^2(\theta) - 1 + \eta \sin^2(\theta)\cos(2\phi) \} (3m^2 - 2)$$

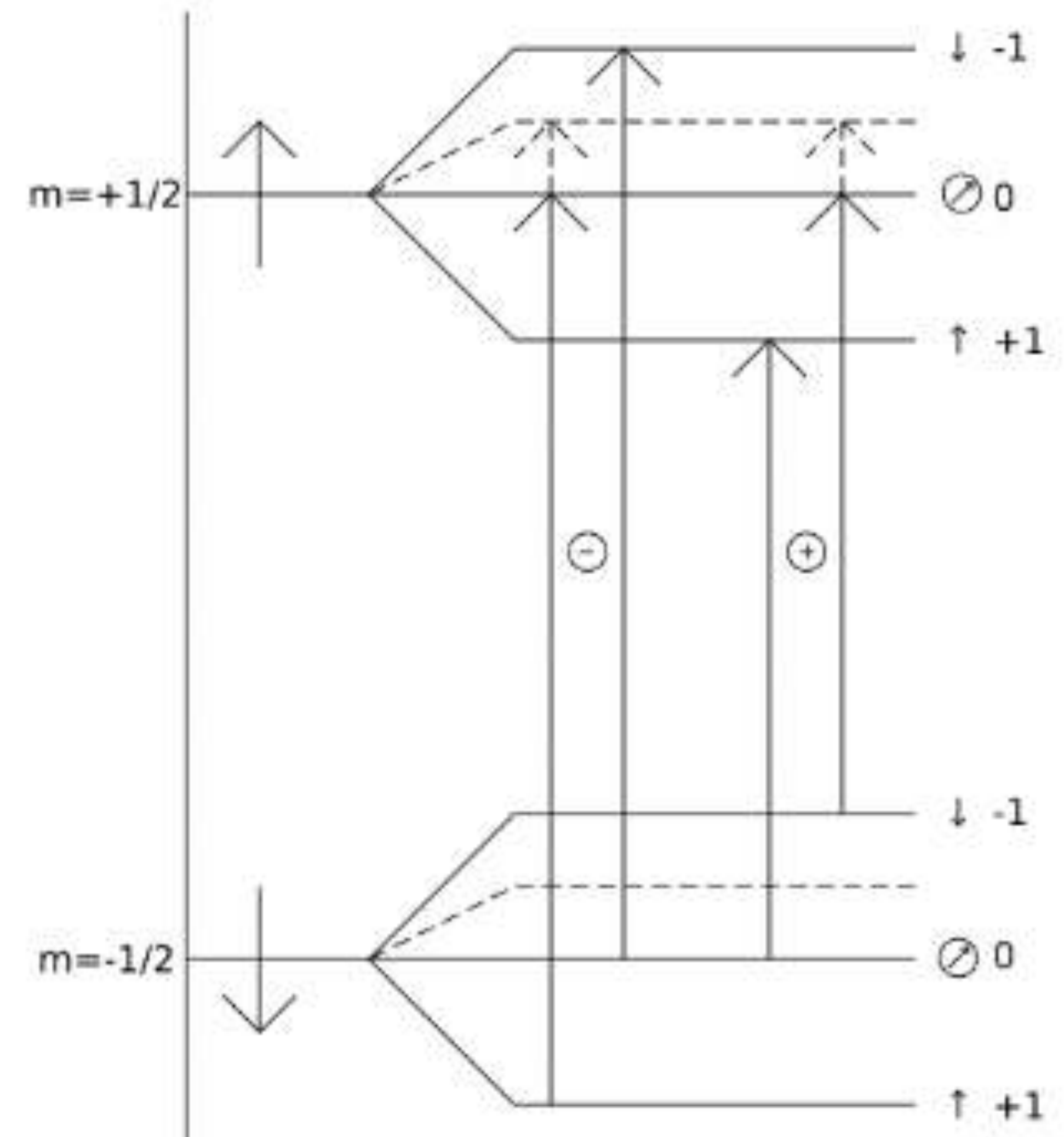

# Deuteron Polarization

## CW-NMR in Polycrystalline Samples

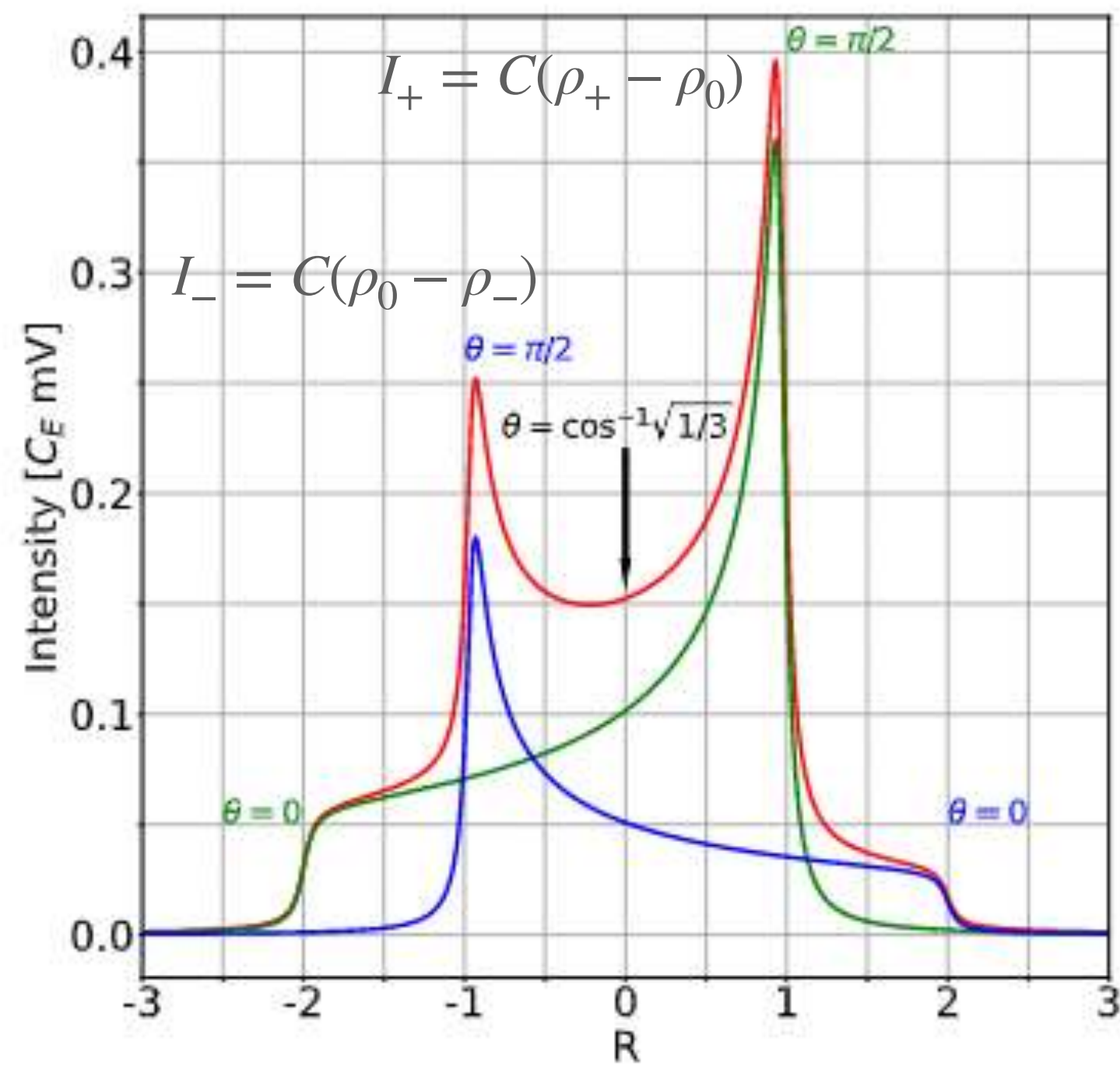

$$P = \frac{\rho_+ - \rho_-}{\rho_+ + \rho_0 - \rho_-}$$

$$Q = \frac{\rho_+ + \rho_- - 2\rho_0}{\rho_+ + \rho_0 - \rho_-}$$

$$R = \frac{\omega - \omega_d}{3\omega_q}$$

$$P = C(I_+ + I_-) = C([\rho_+ - \rho_0] + [\rho_0 - \rho_-])$$

$$Q = C(I_+ - I_-) = C([\rho_+ - \rho_0] - [\rho_0 - \rho_-])$$

$$E_m = -\hbar\omega_d m + \hbar\omega_q \{3 \cos^2(\theta) - 1 + \eta \sin^2(\theta) \cos(2\phi)\} (3m^2 - 2)$$

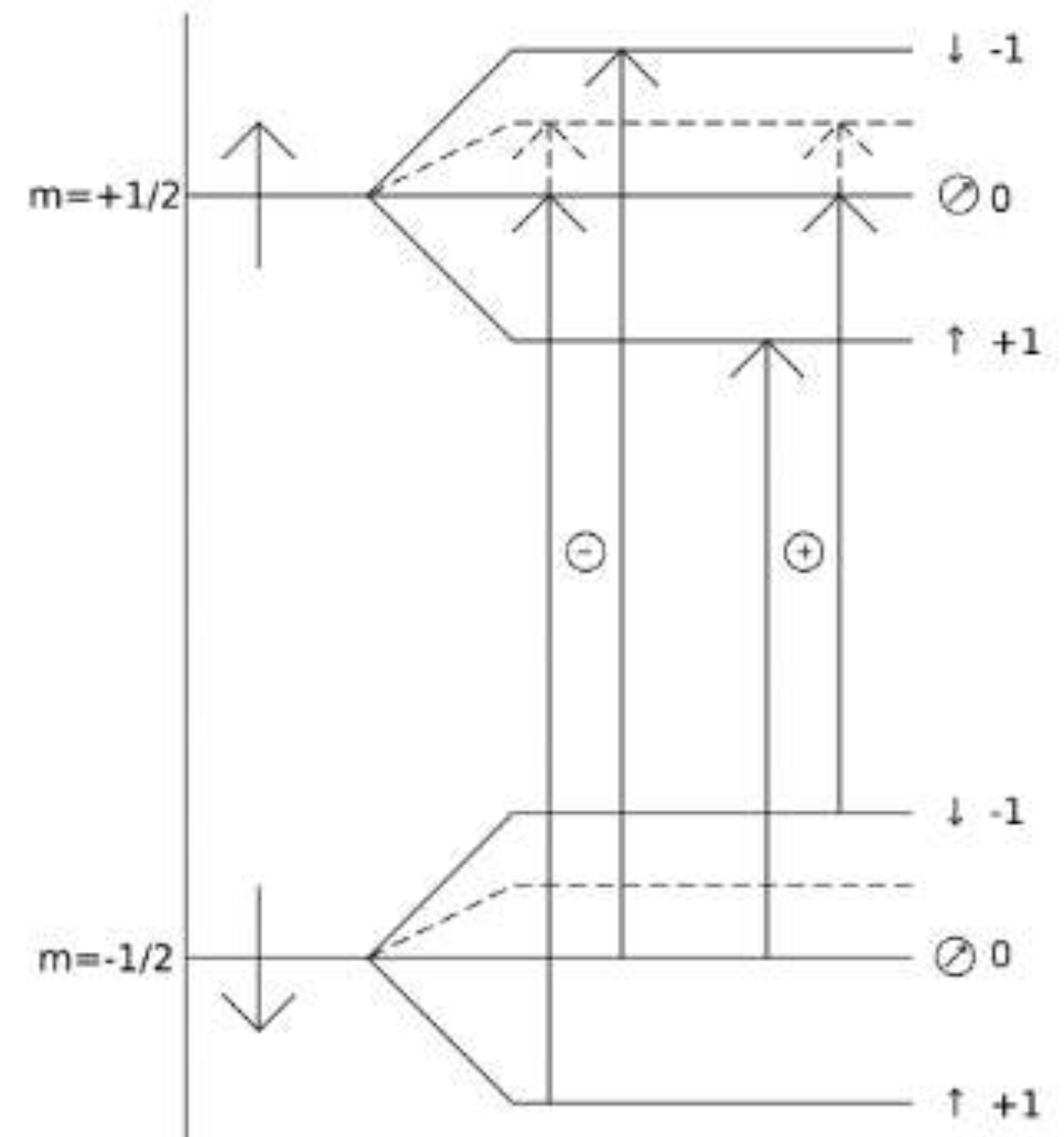

# Deuteron Polarization

## CW-NMR in Polycrystalline Samples

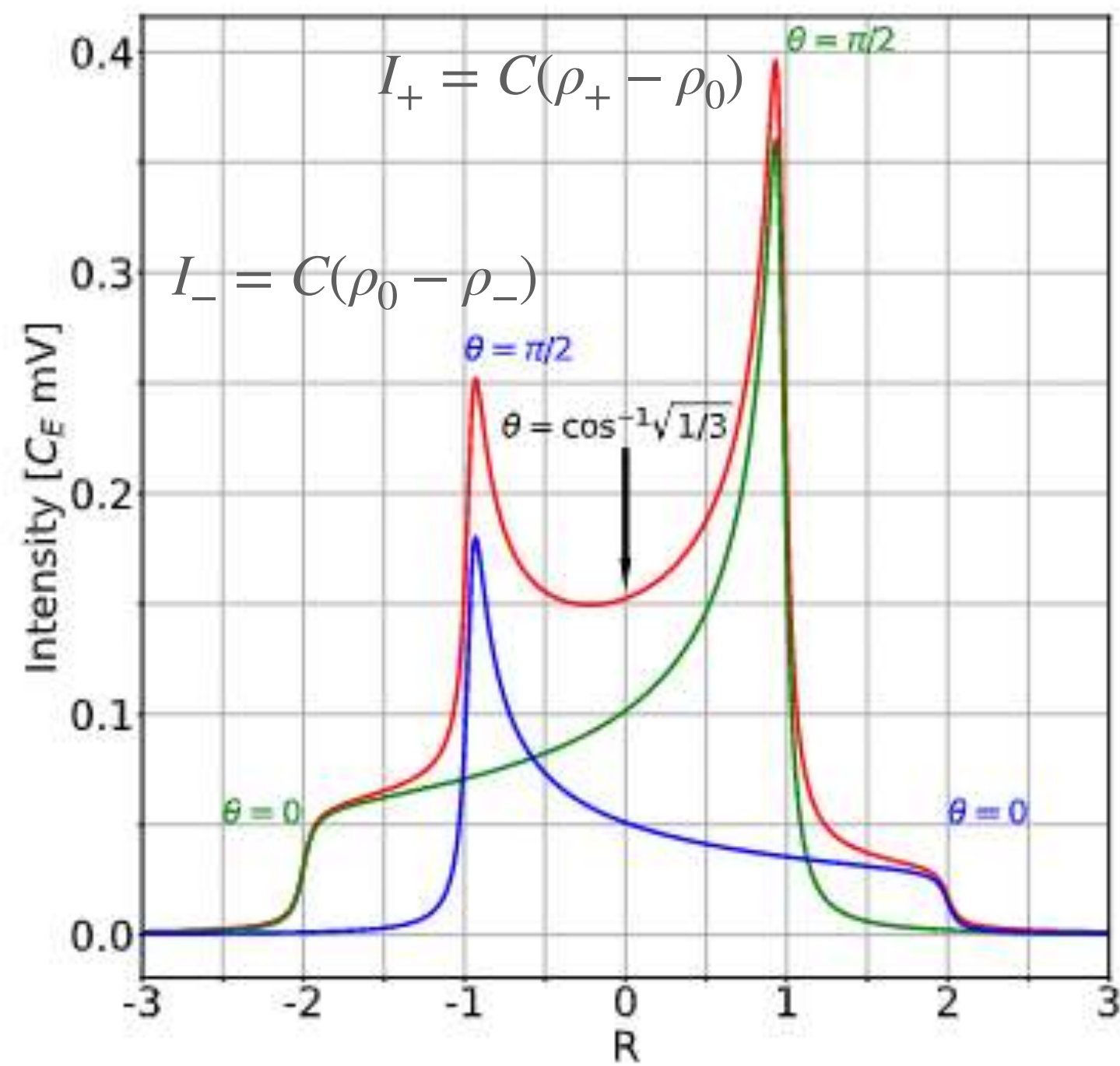

$$P = \frac{\rho_+ - \rho_-}{\rho_+ + \rho_0 - \rho_-}$$

$$Q = \frac{\rho_+ + \rho_- - 2\rho_0}{\rho_+ + \rho_0 - \rho_-}$$

$$R = \frac{\omega - \omega_d}{3\omega_q}$$

$$Q = 2 - \sqrt{4 - 3P^2}$$

$$E_m = -\hbar\omega_d m + \hbar\omega_q \{3 \cos^2(\theta) - 1 + \eta \sin^2(\theta) \cos(2\phi)\} (3m^2 - 2)$$

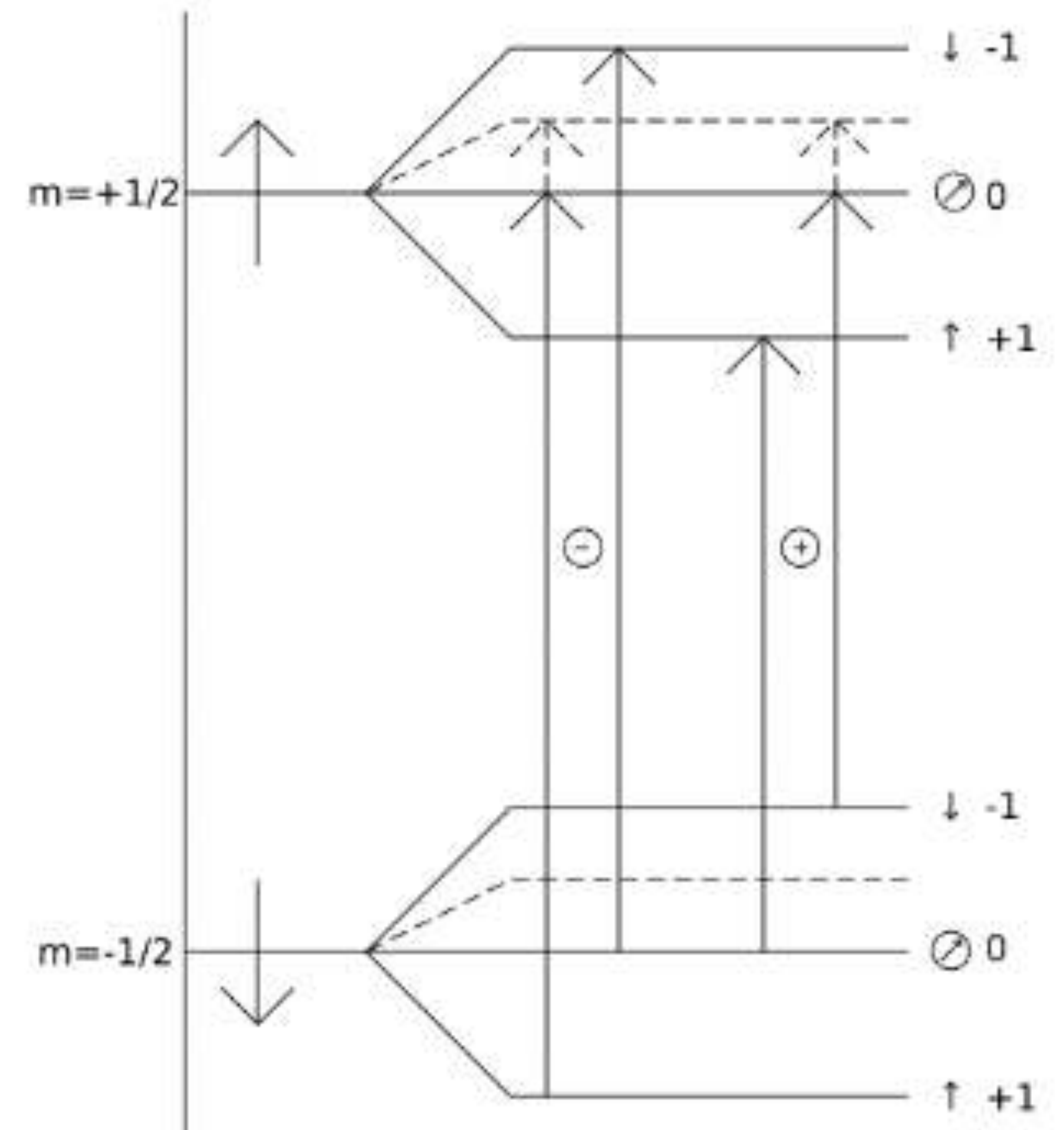

# Charge-1

## Technique to Enhance the Tensor Polarization

- We use Selective Semi-saturating RF to alter the energy level populations
  - RF close to Larmor frequency from a separate source than the DNP and NMR
  - Selective: Select the range in the frequency domain to RF
  - Semi-saturating: Monitor and respond using RF power control and timing
- Instrumentation is specialized to generate RF
  - Separate coil to apply ssRF
  - Q-meter based NMR with RF switch
  - RF amplification with fine control and capacity to modulate rapidly over domain

# Application of RF In Selective Semi-saturation

$$P = C(I_+ + I_-)$$

$$Q = C(I_+ - I_-)$$

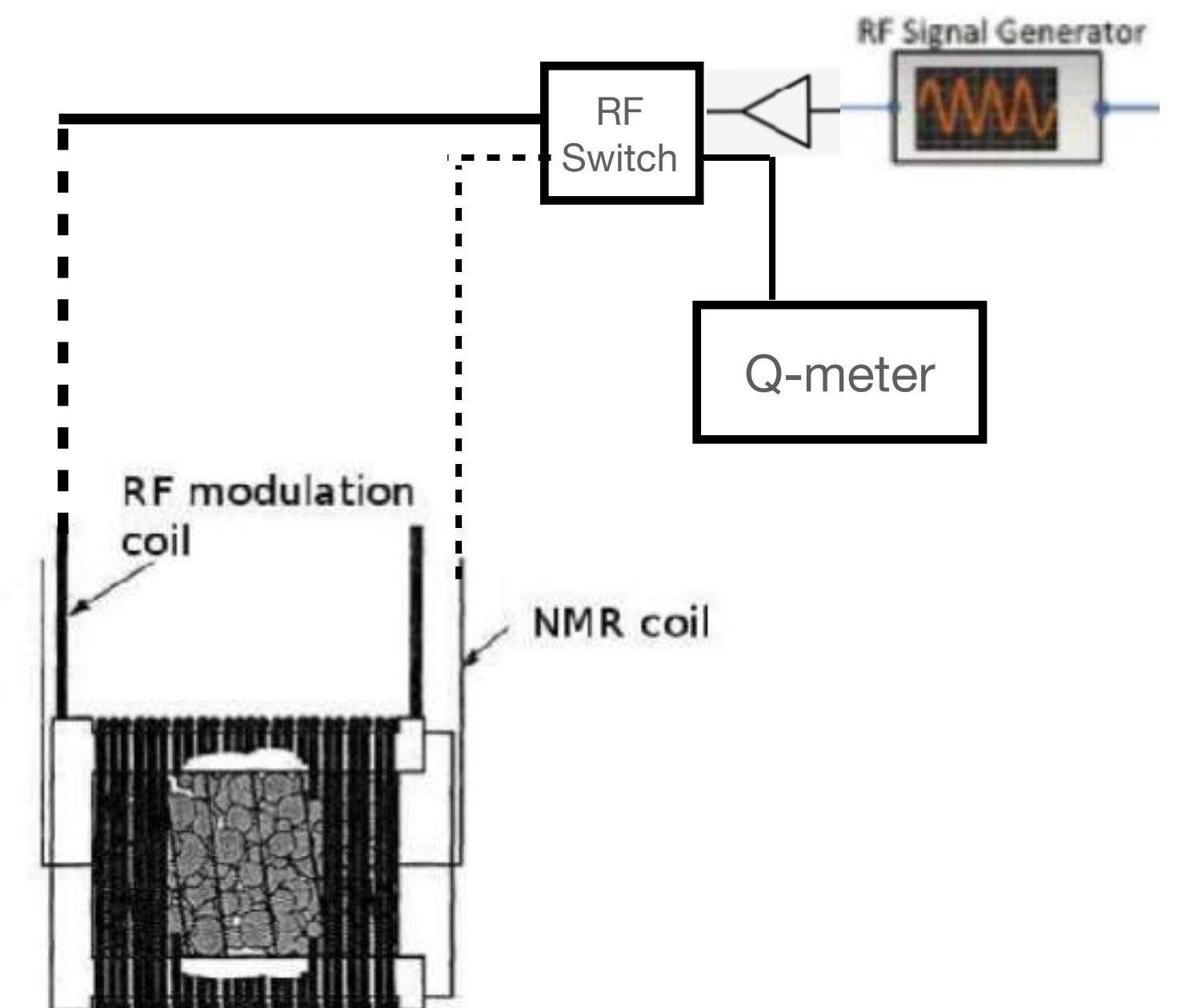
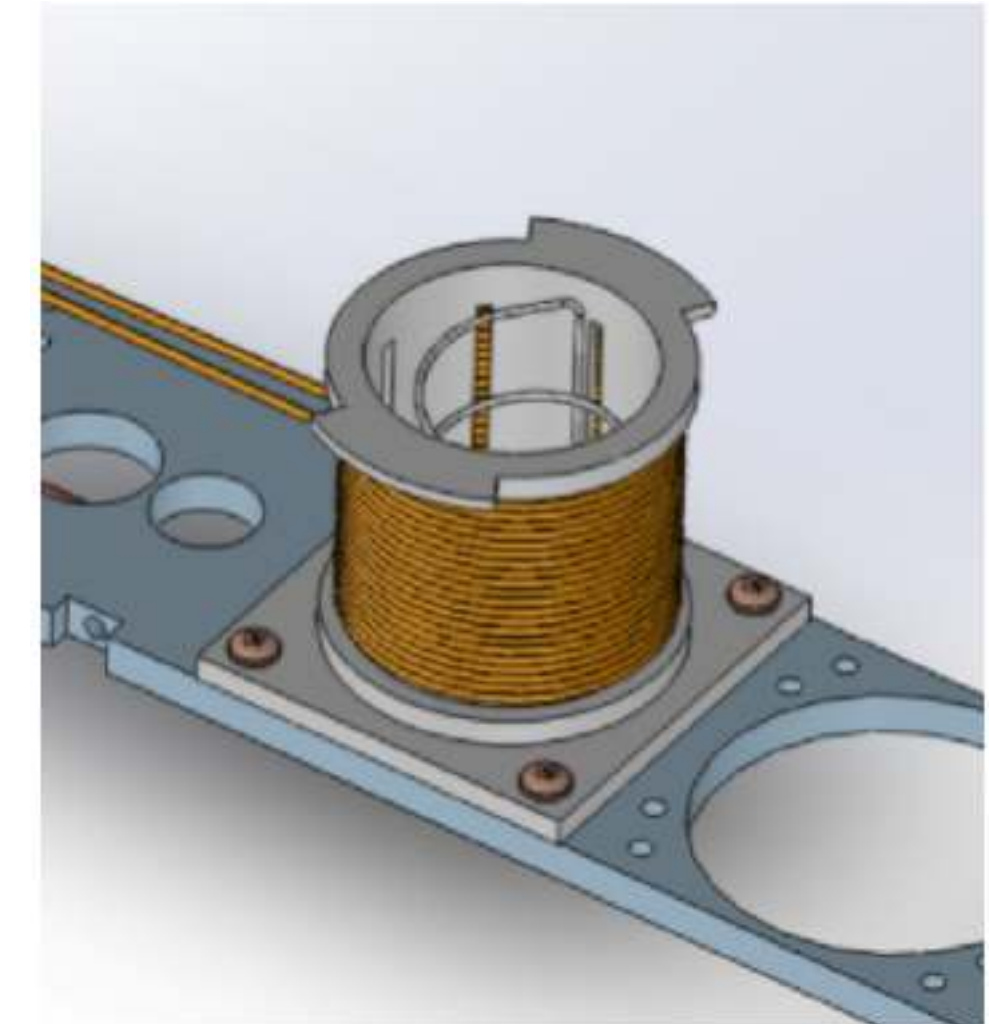
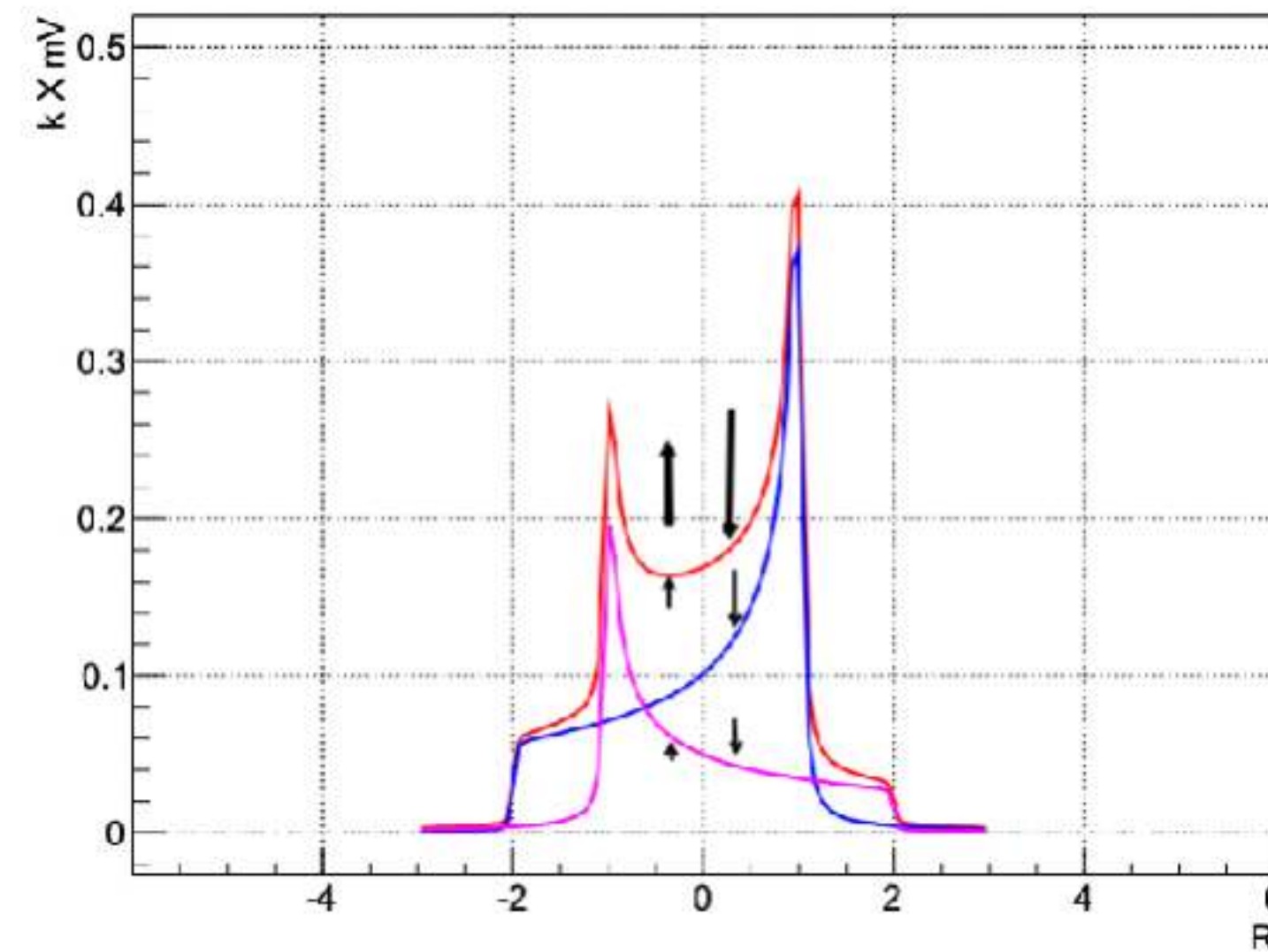
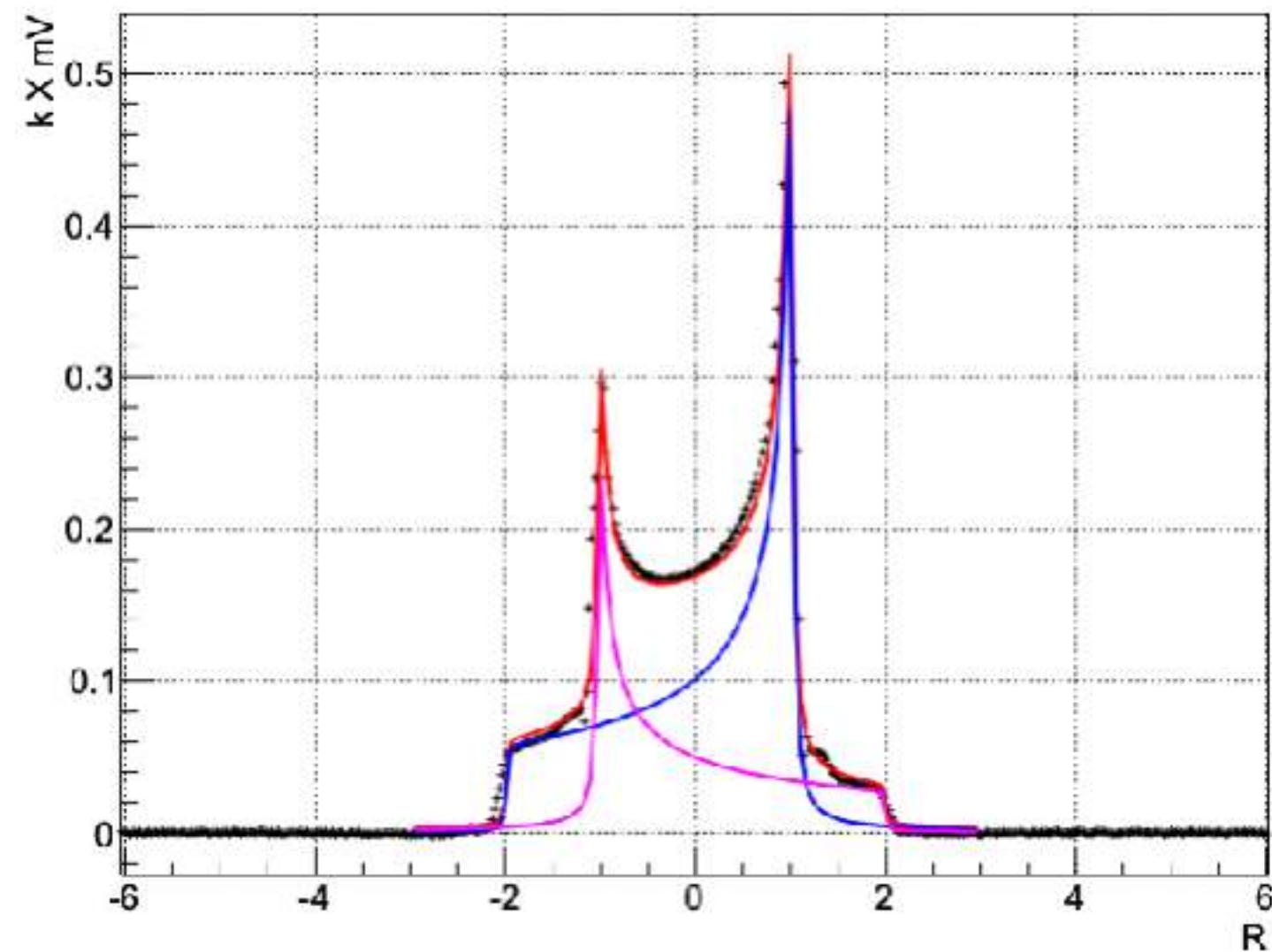

# Application of RF In Selective Semi-saturation

$$P = C(I_+ + I_-)$$

$$Q = C(I_+ - I_-)$$

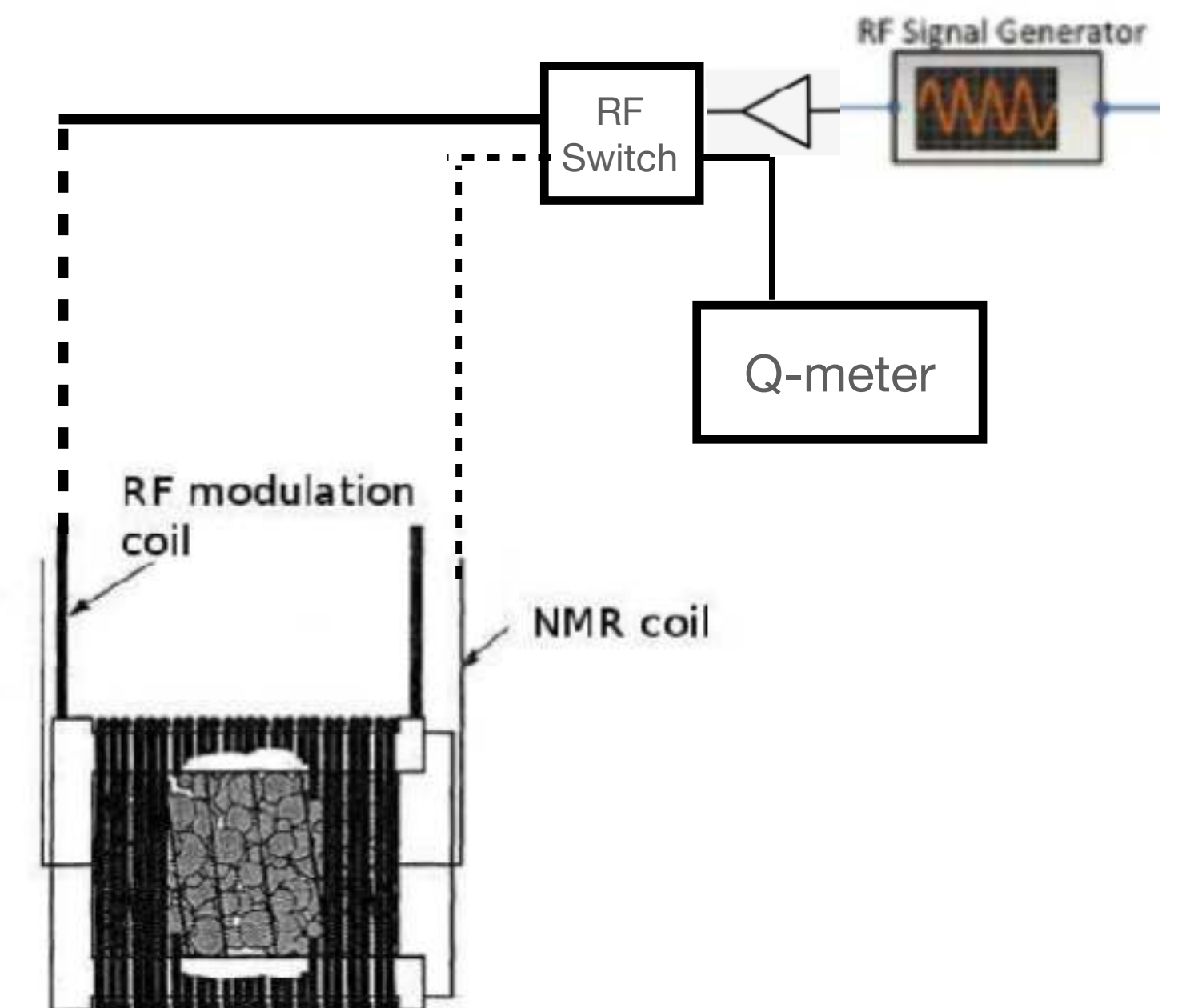
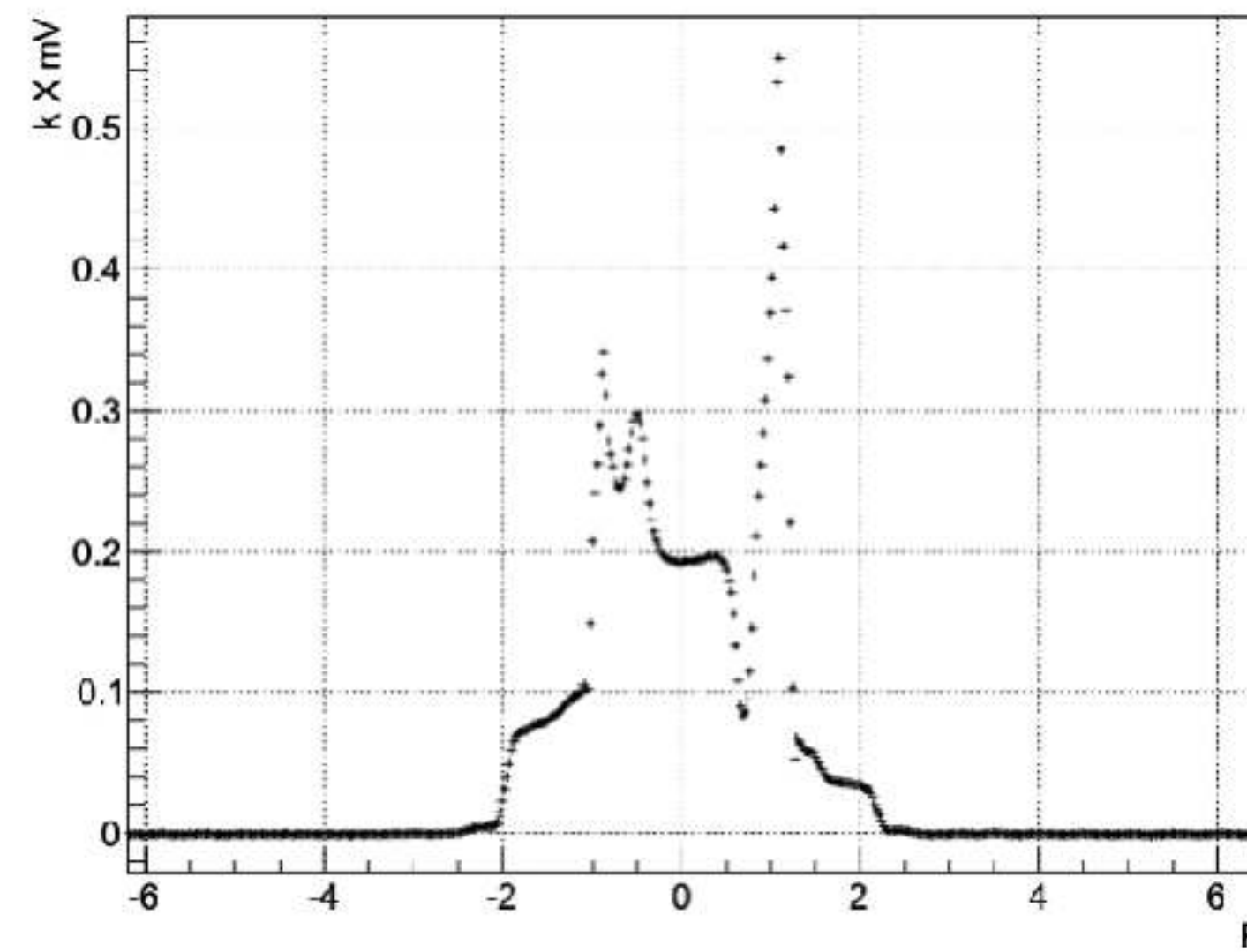
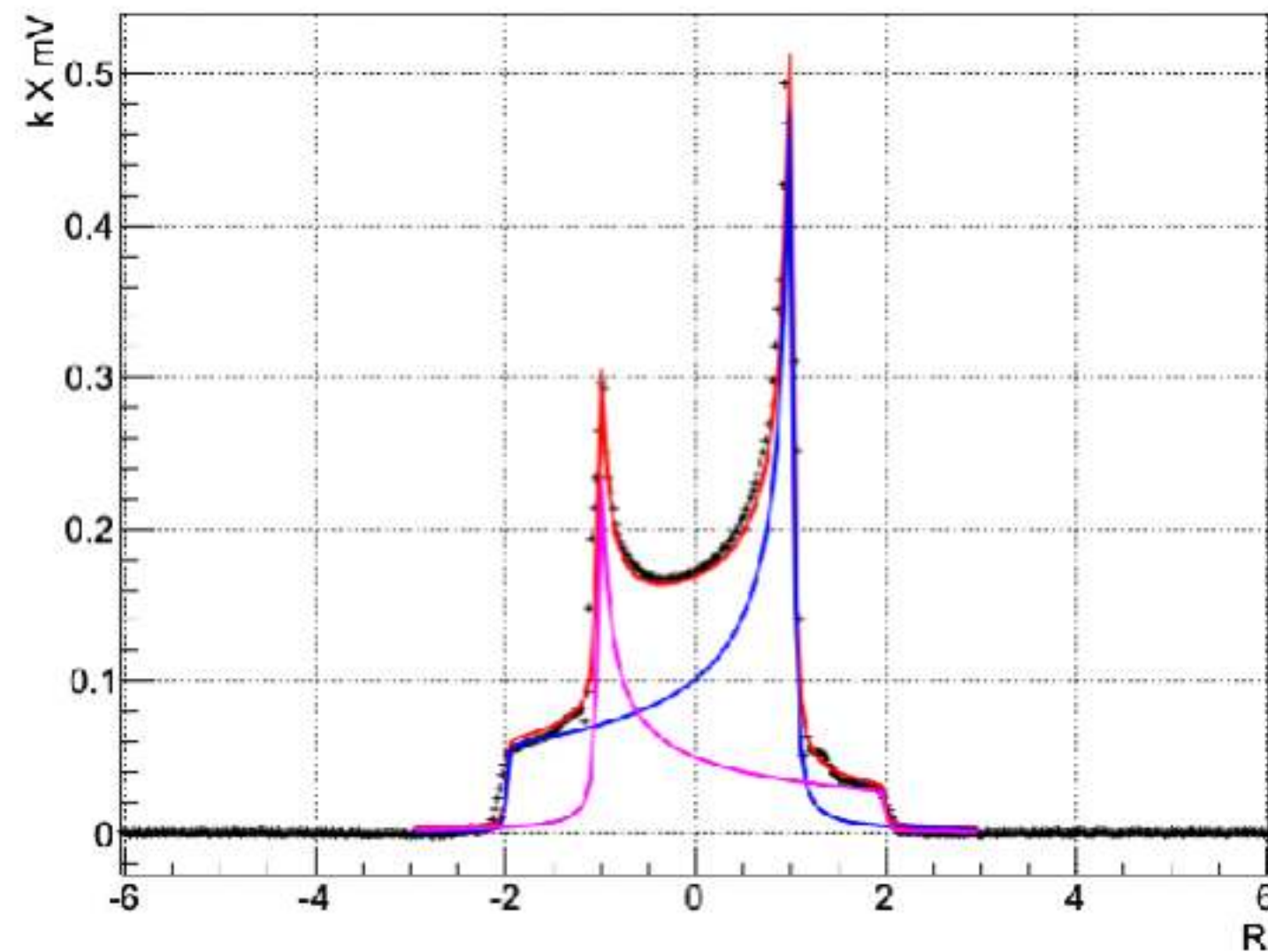
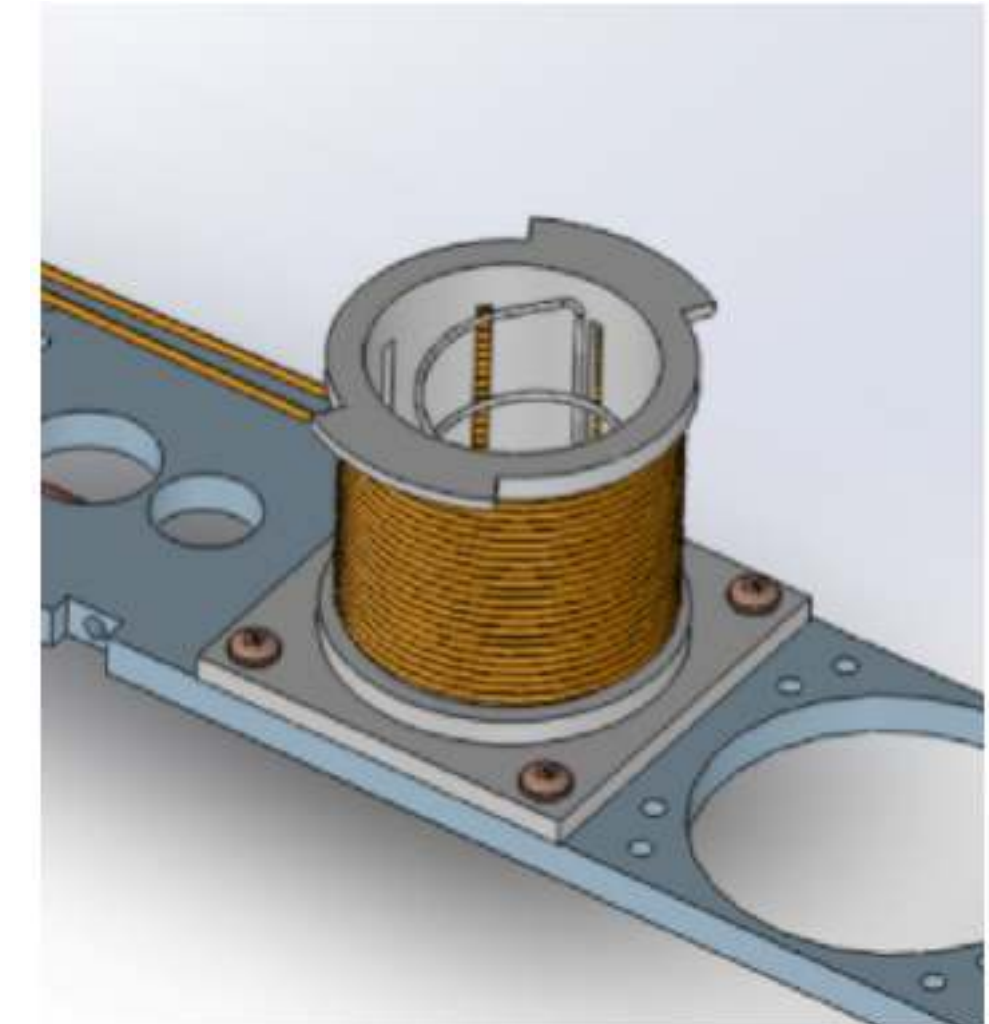



# Application of RF In Selective Semi-saturation

$$P = C(I_+ + I_-)$$

$$Q = C(I_+ - I_-)$$

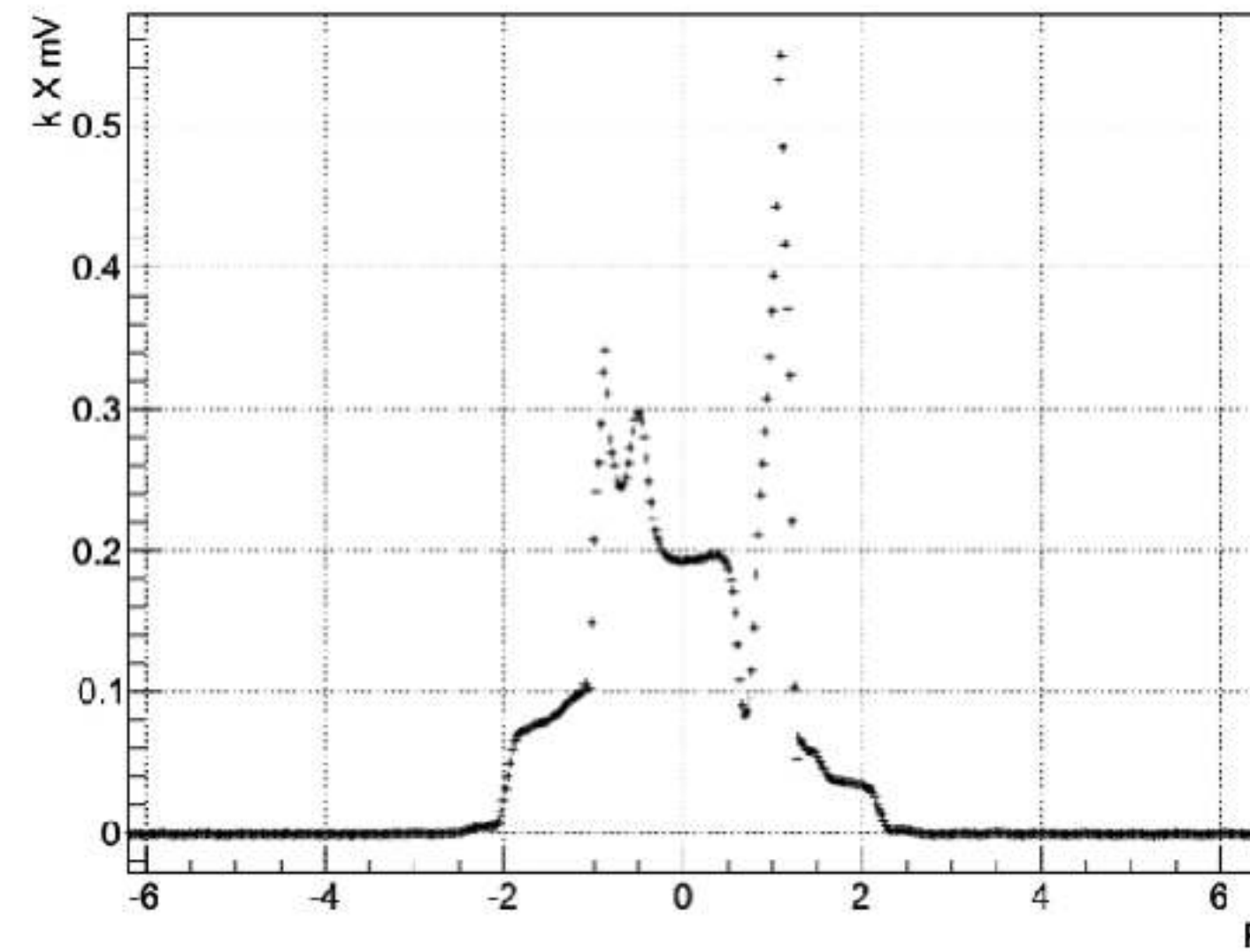
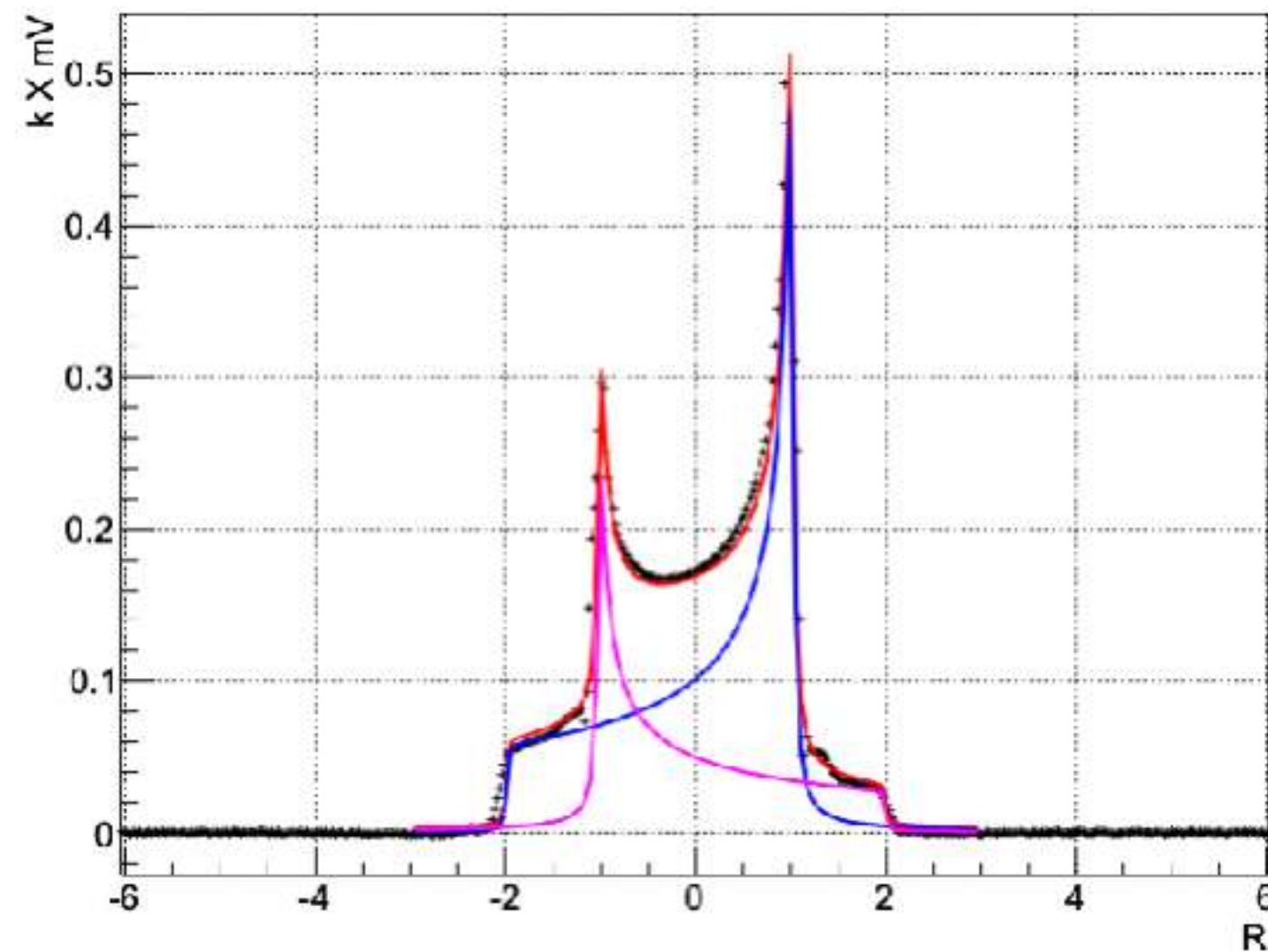

*To enhance tensor polarization we must maximize the difference in  $I_+$  and  $I_-$*

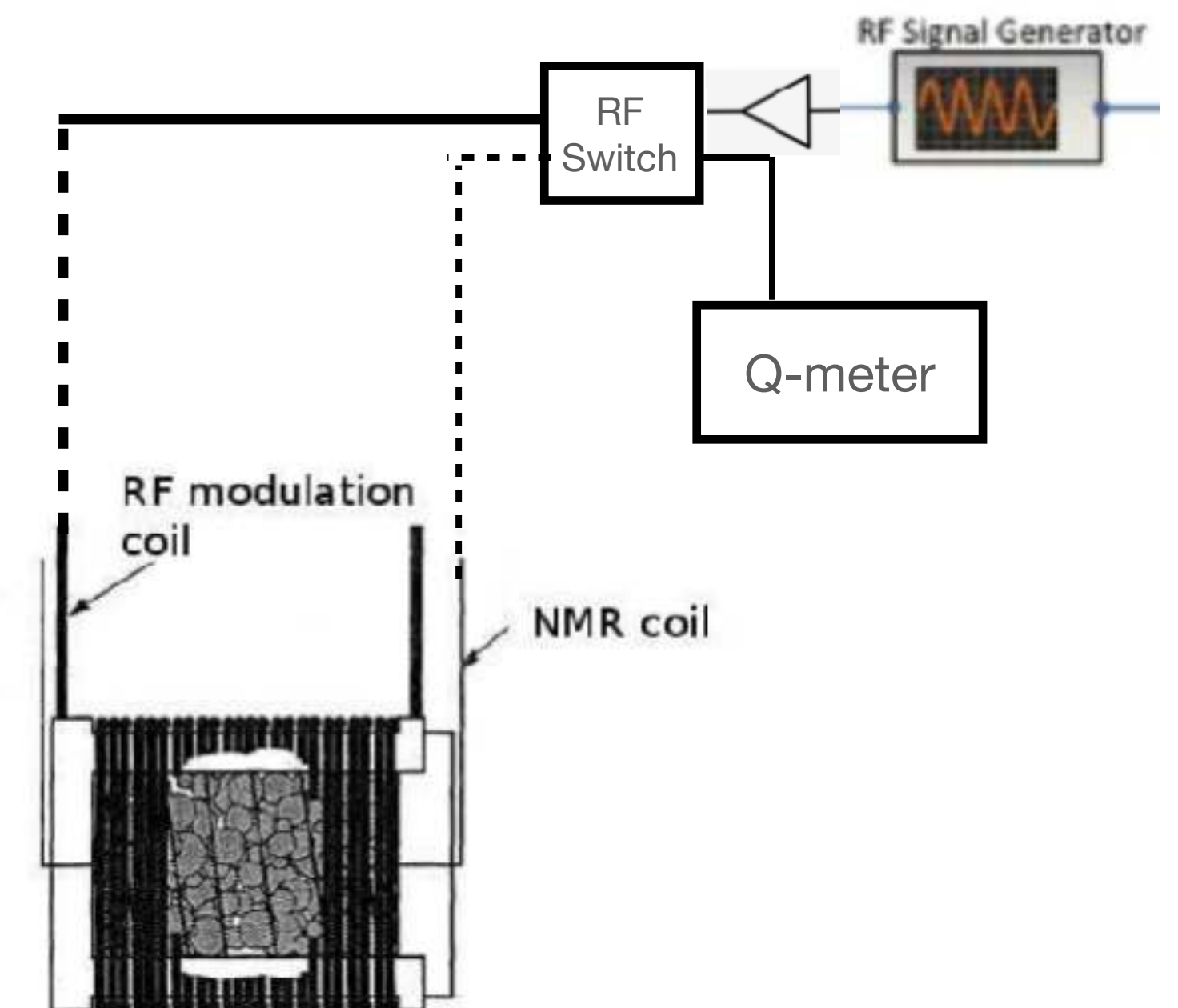
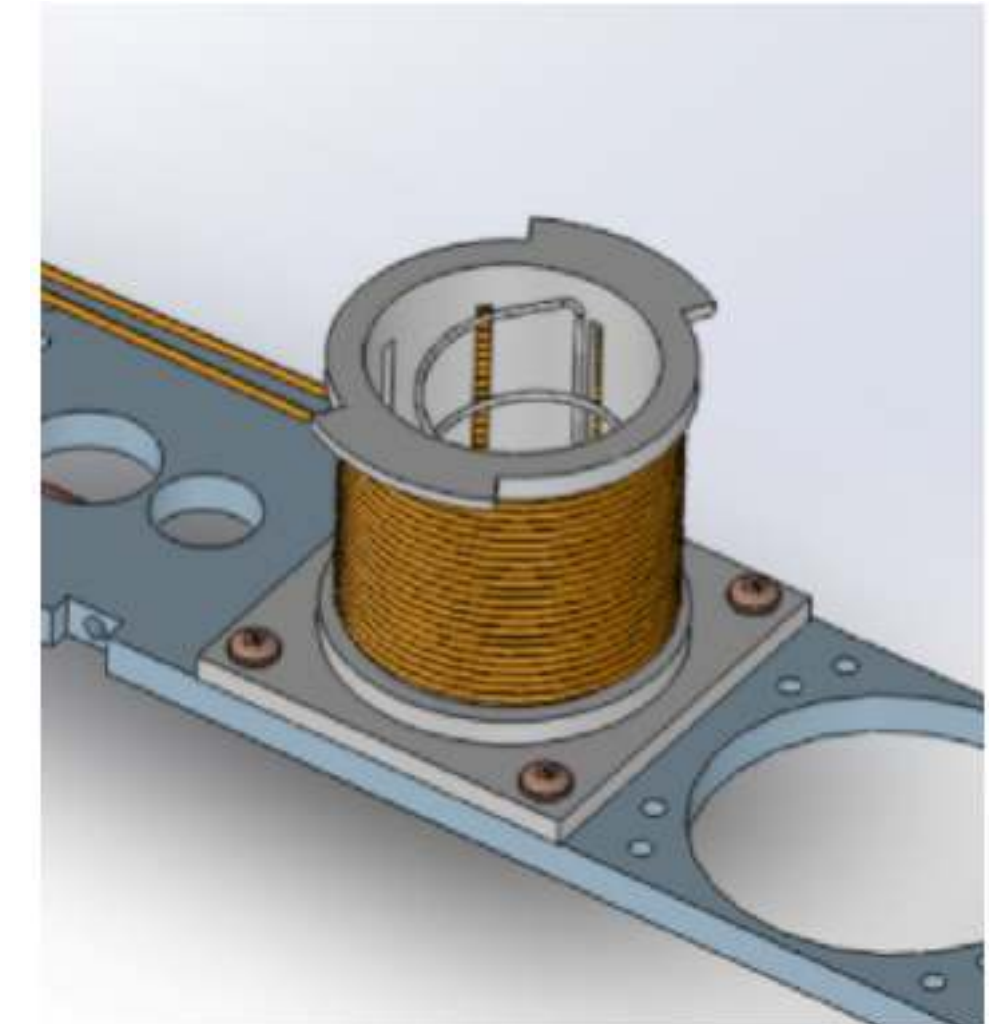

# Charge-2

## How to Measure and What is the Error

- Measure
  - Assume TE and Boltzmann signal studies done well during calibration
  - Use the **3-principles** extraction
  - Continue to sweep-measure/sweep-manipulate
- Uncertainty
  - Additional Error from modulating but have tools to improve

# The Three Principles

For Enhanced Tensor Polarization that can be measured

*A. Differential Binning*

*B. Spin Temperature Consistency*

*C. Rates Response*

The principles are being written up in NIM for clarity and reliability of measurement

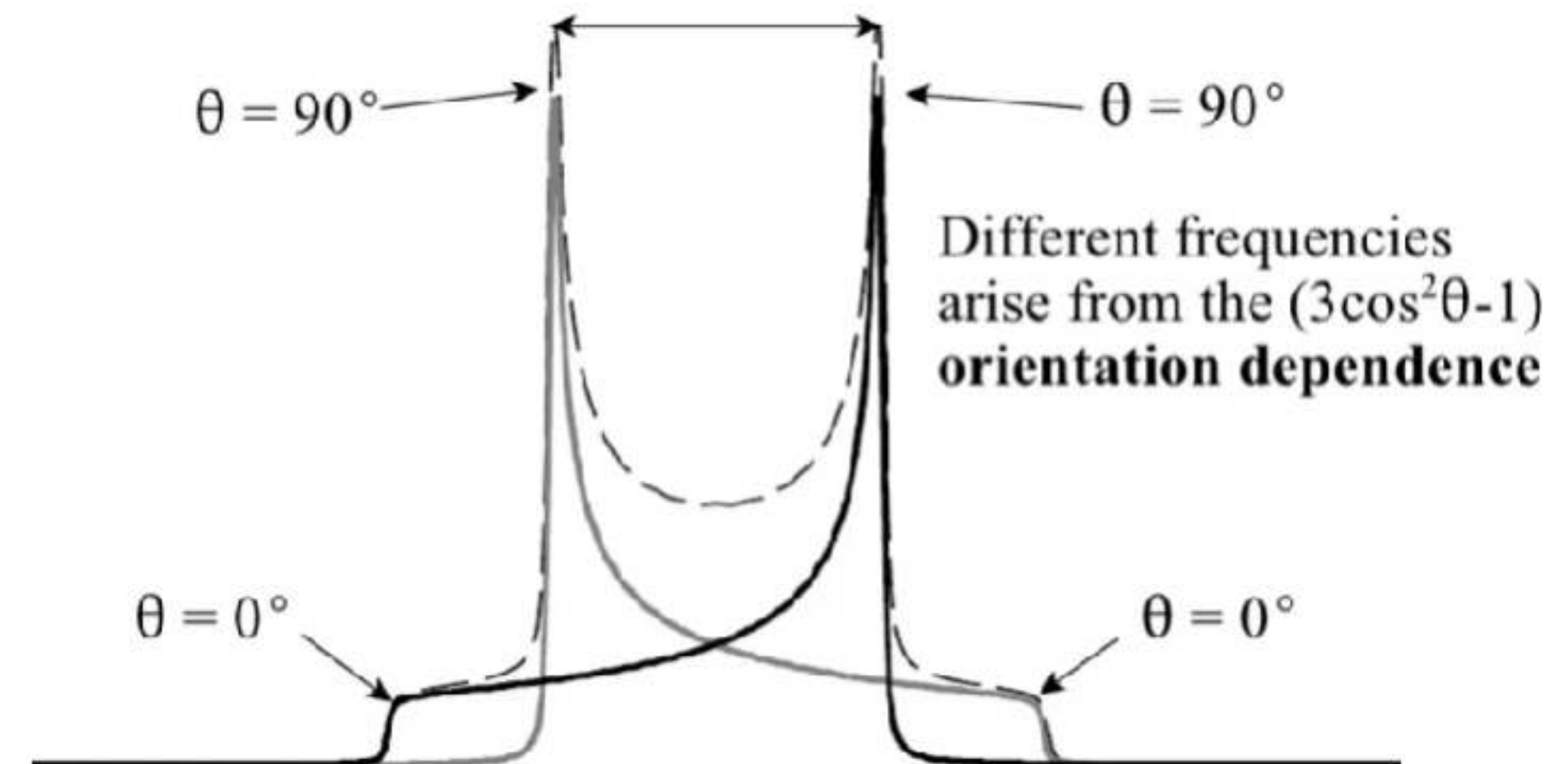

# Differential Binning

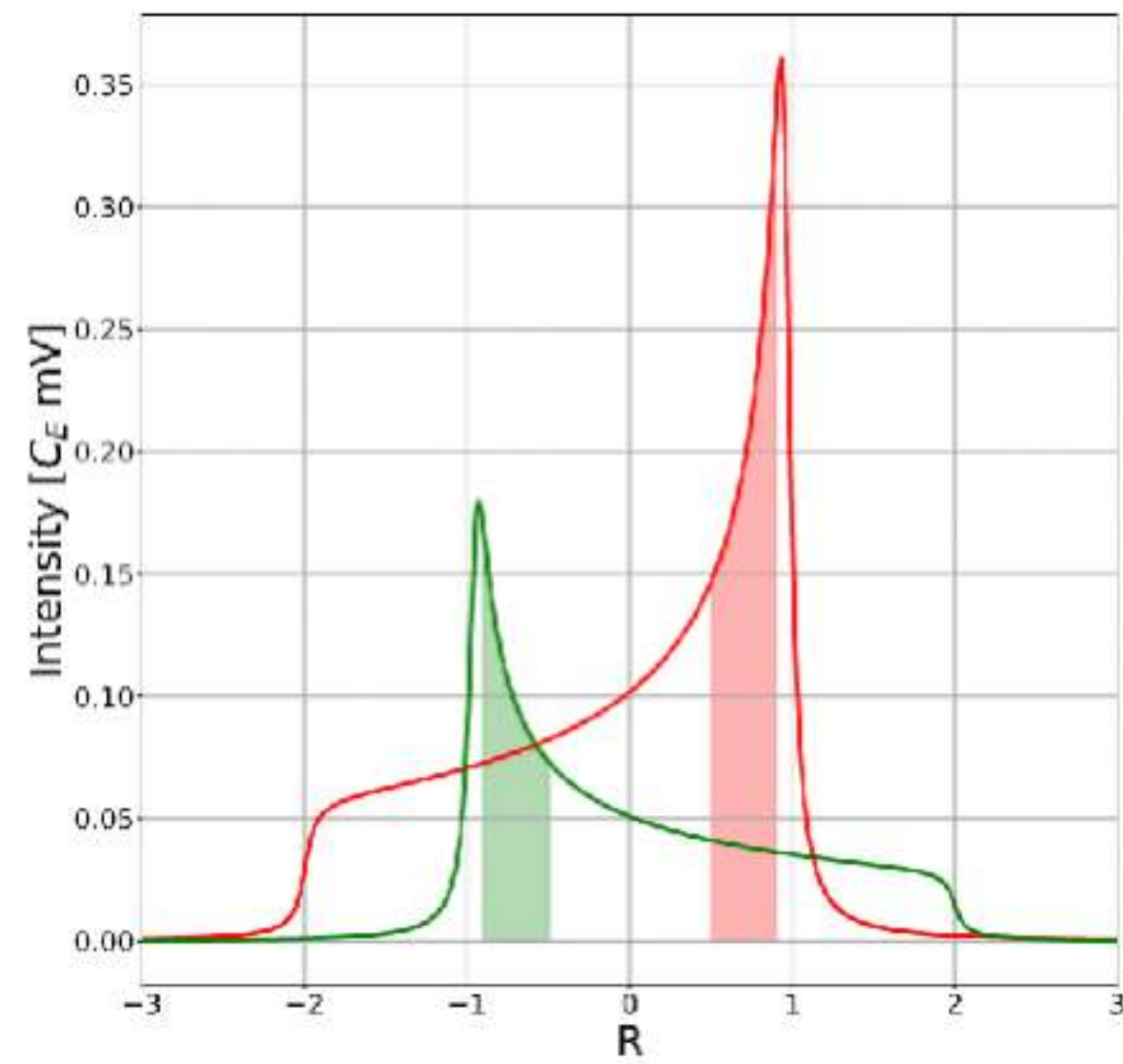

$$P = C(I_+ + I_-)$$

$$Q = C(I_+ - I_-)$$

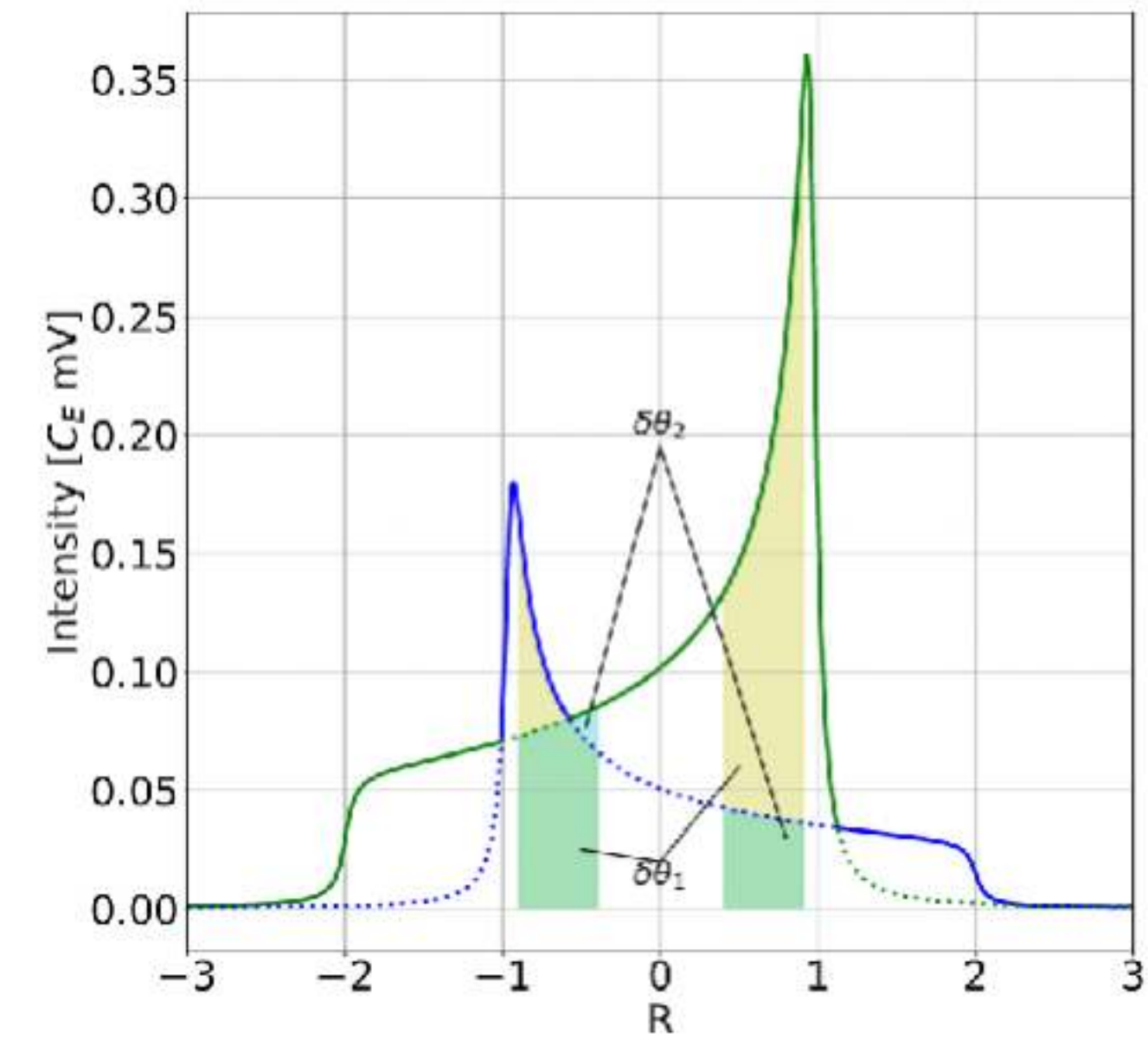

Depolarized back to zero

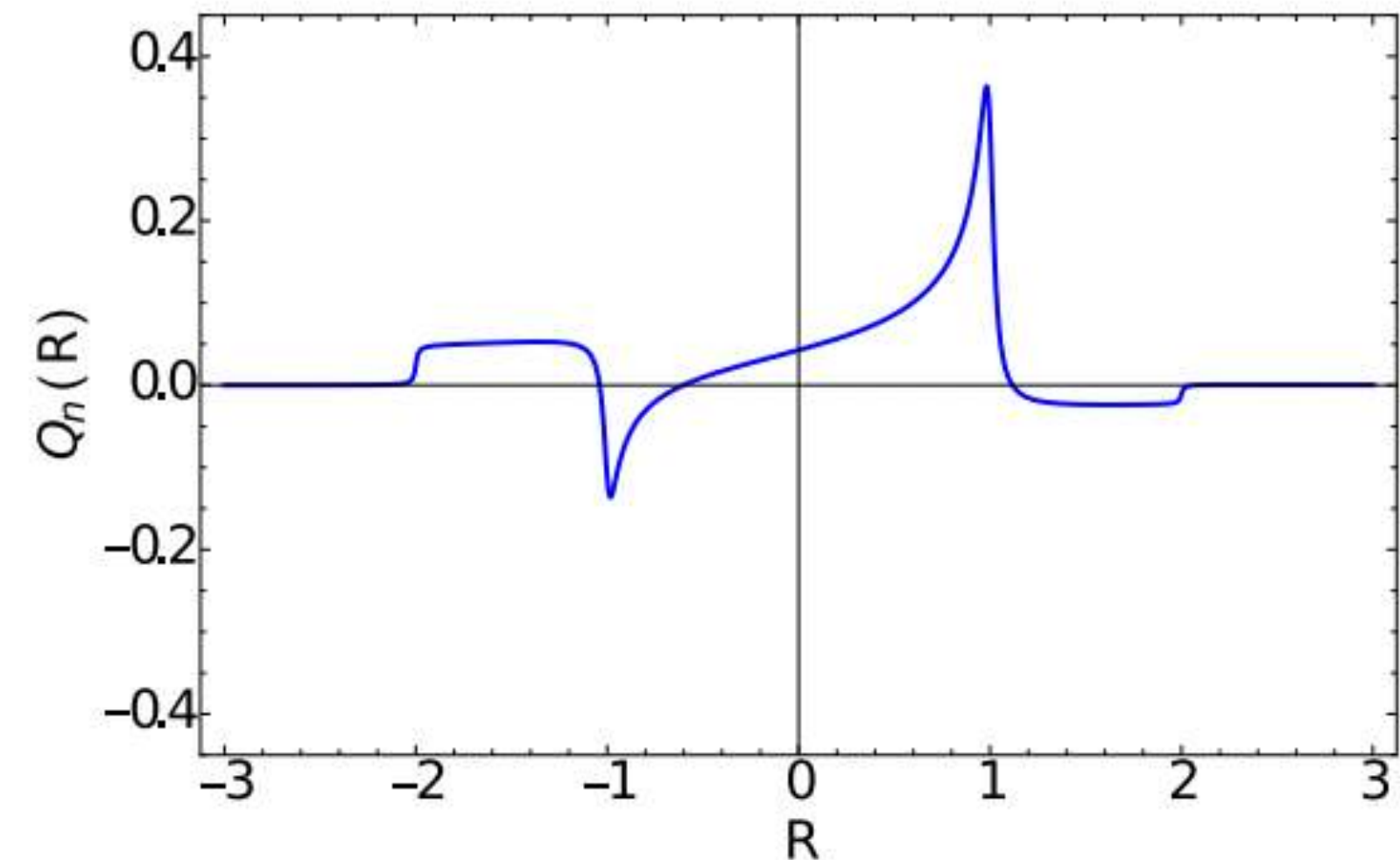
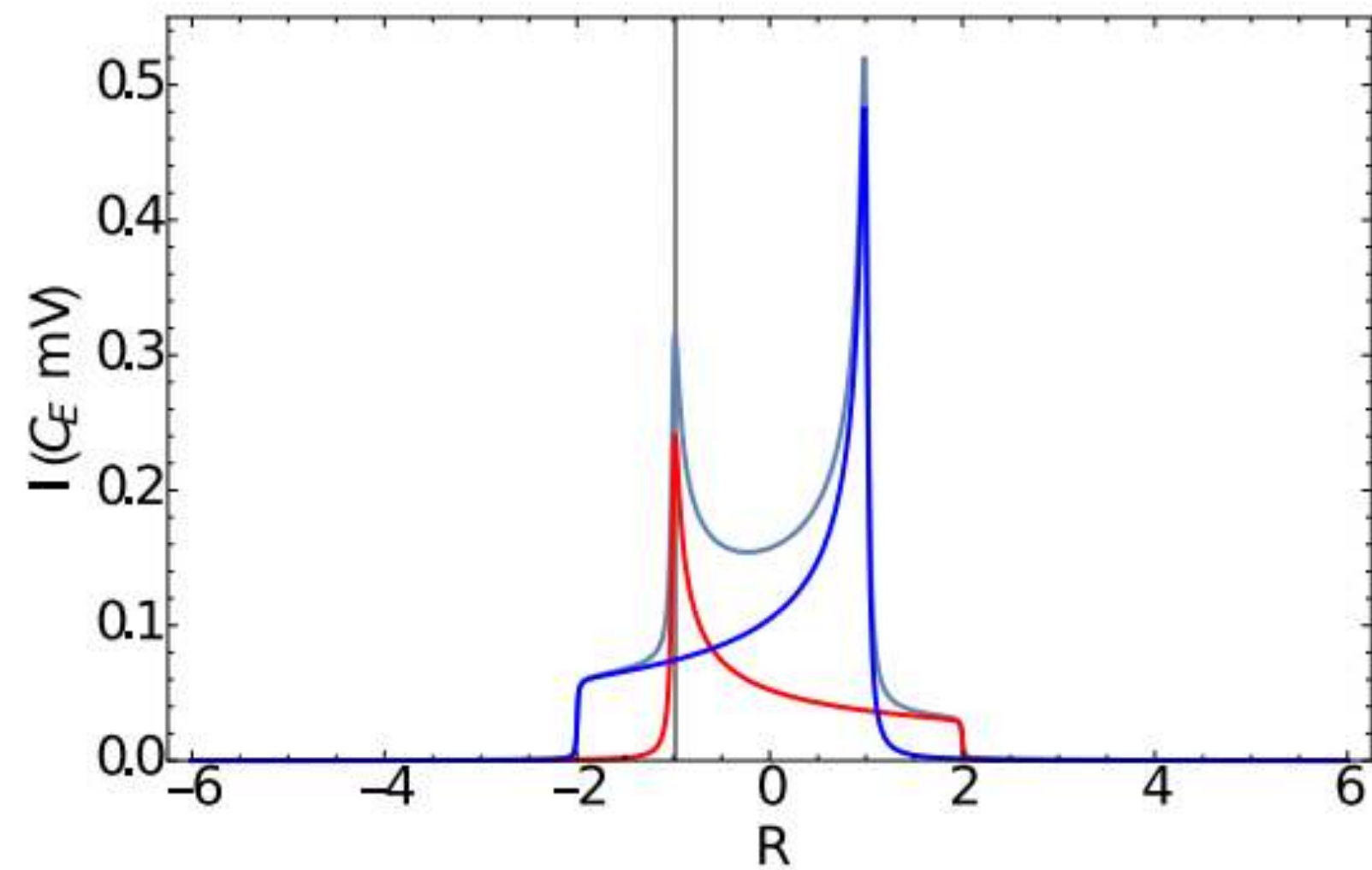

# Spin Temperature Consistency or strategic depolarization

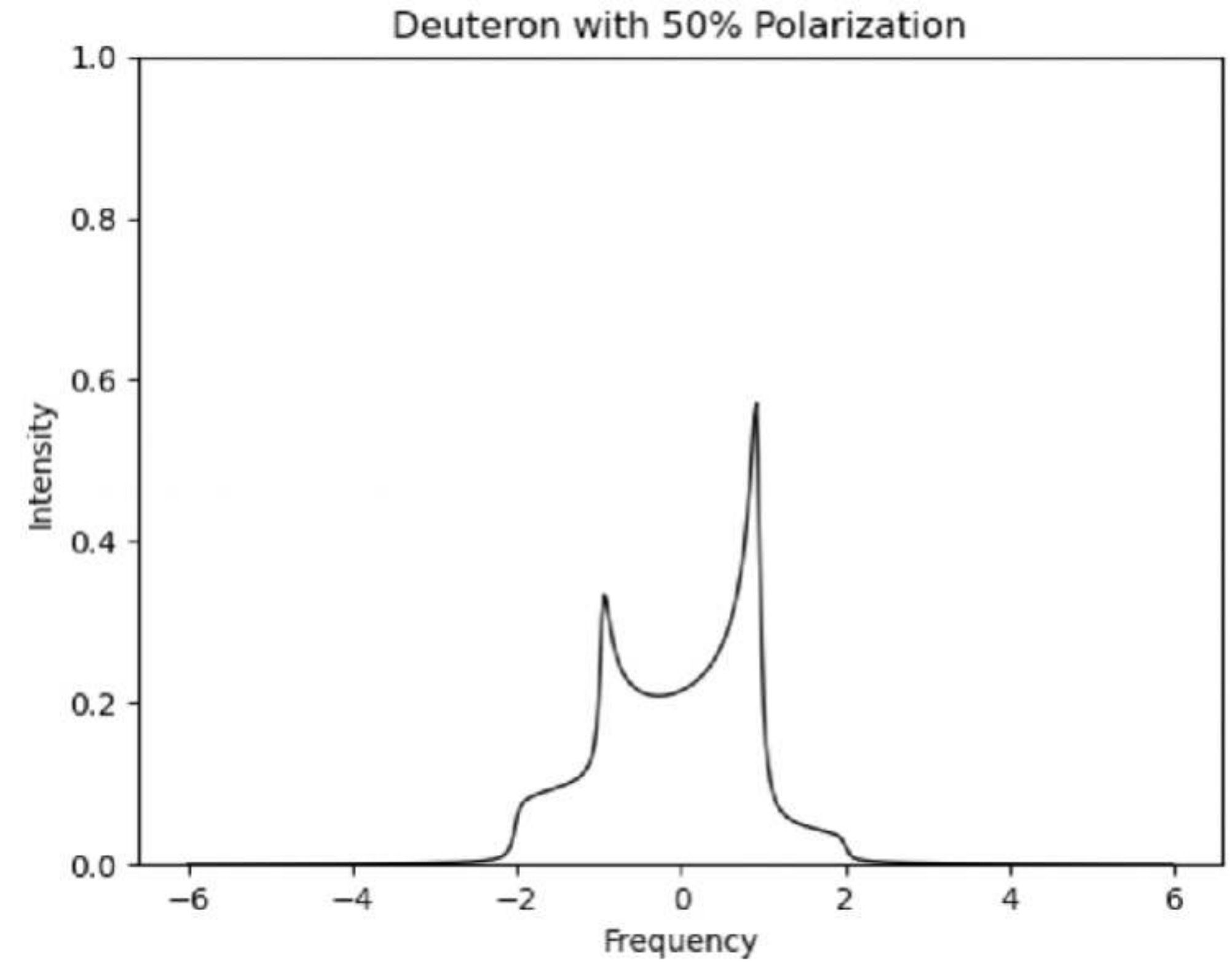
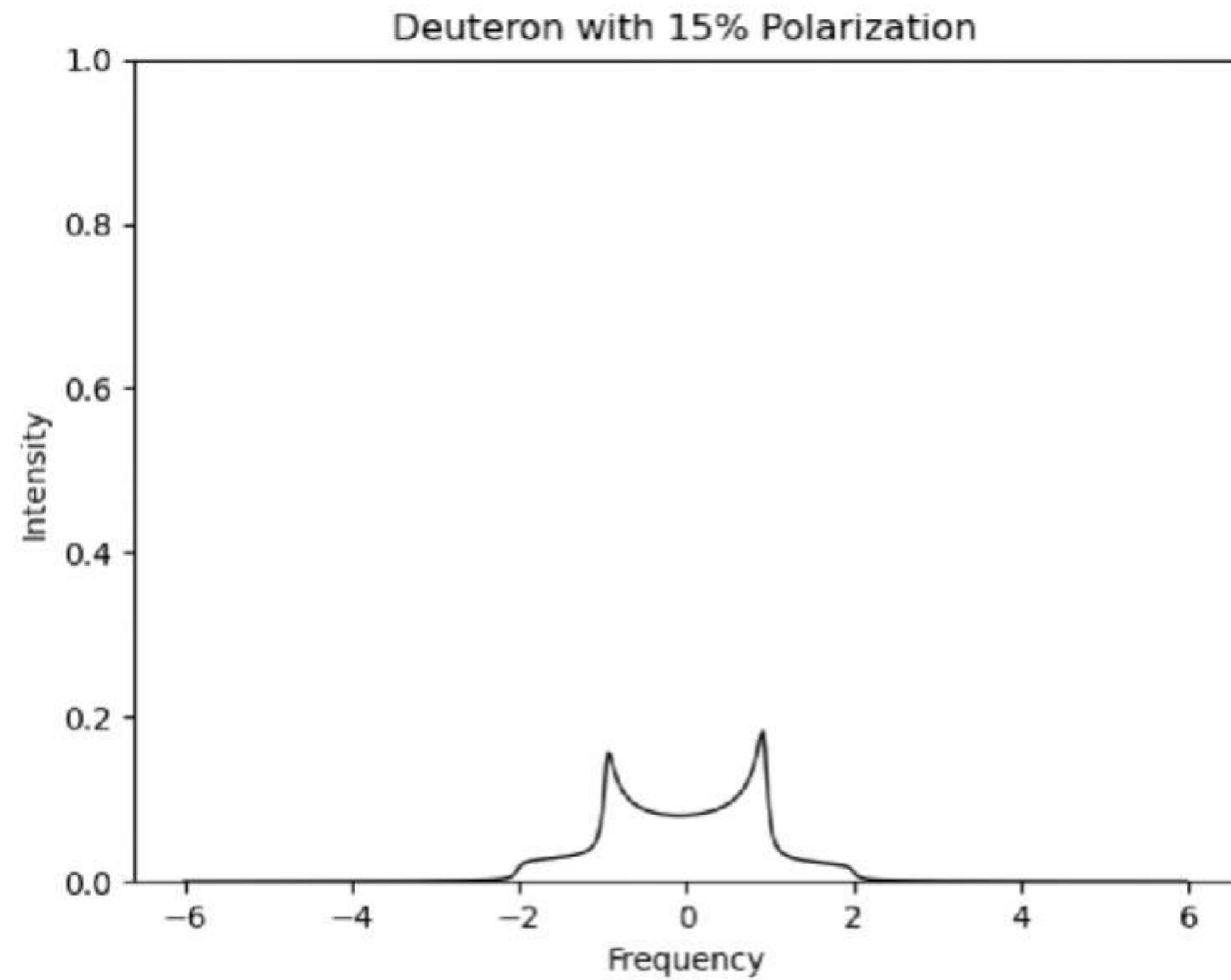

# Spin Temperature Consistency or strategic depolarization

Applying saturating or semi-saturating RF  
Can only ever depolarize

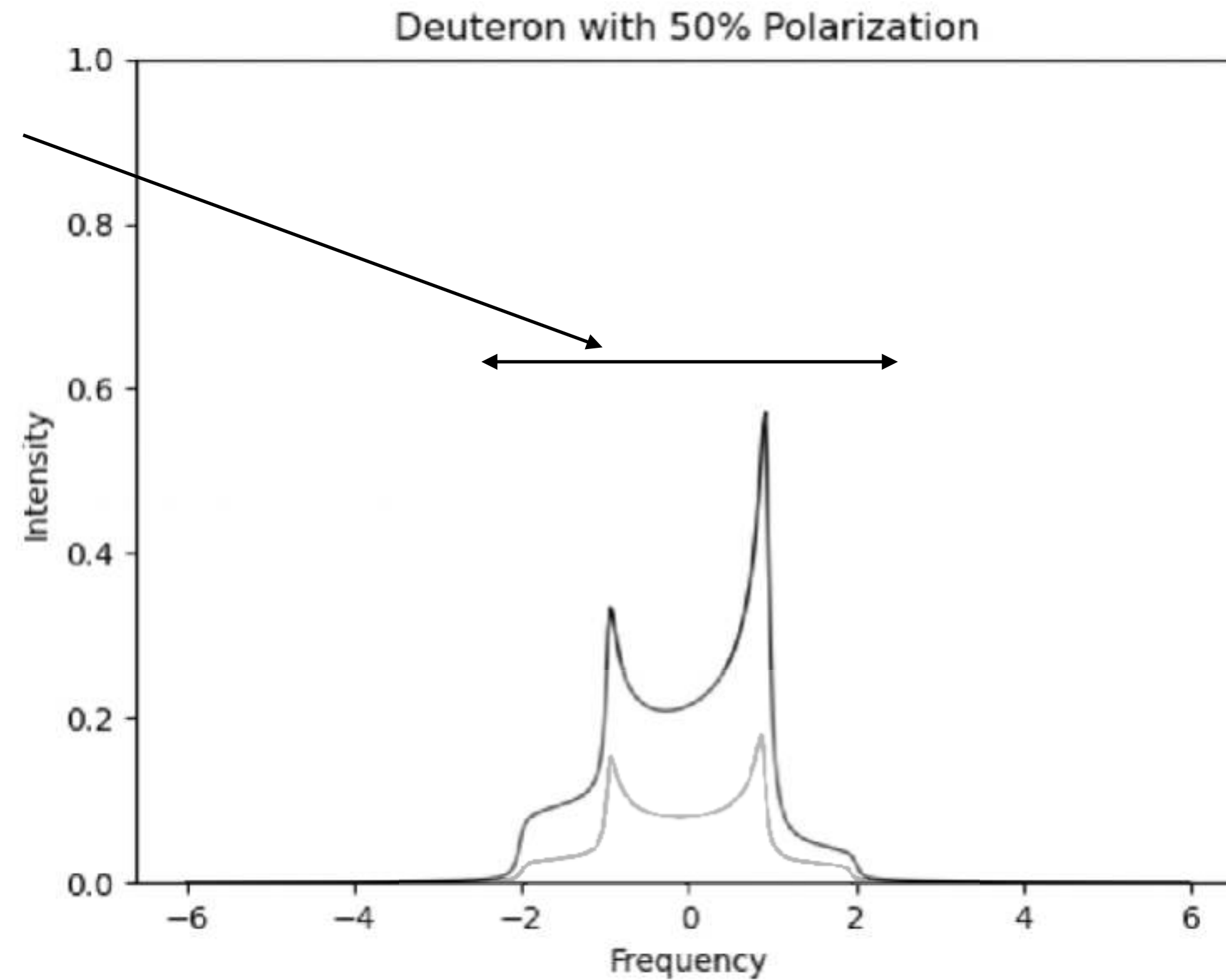

$$\omega_m \gg 2\pi/T_1$$

Fast enough that we treat this  
As the application of a homogeneous field

# Spin Temperature Consistency or strategic depolarization

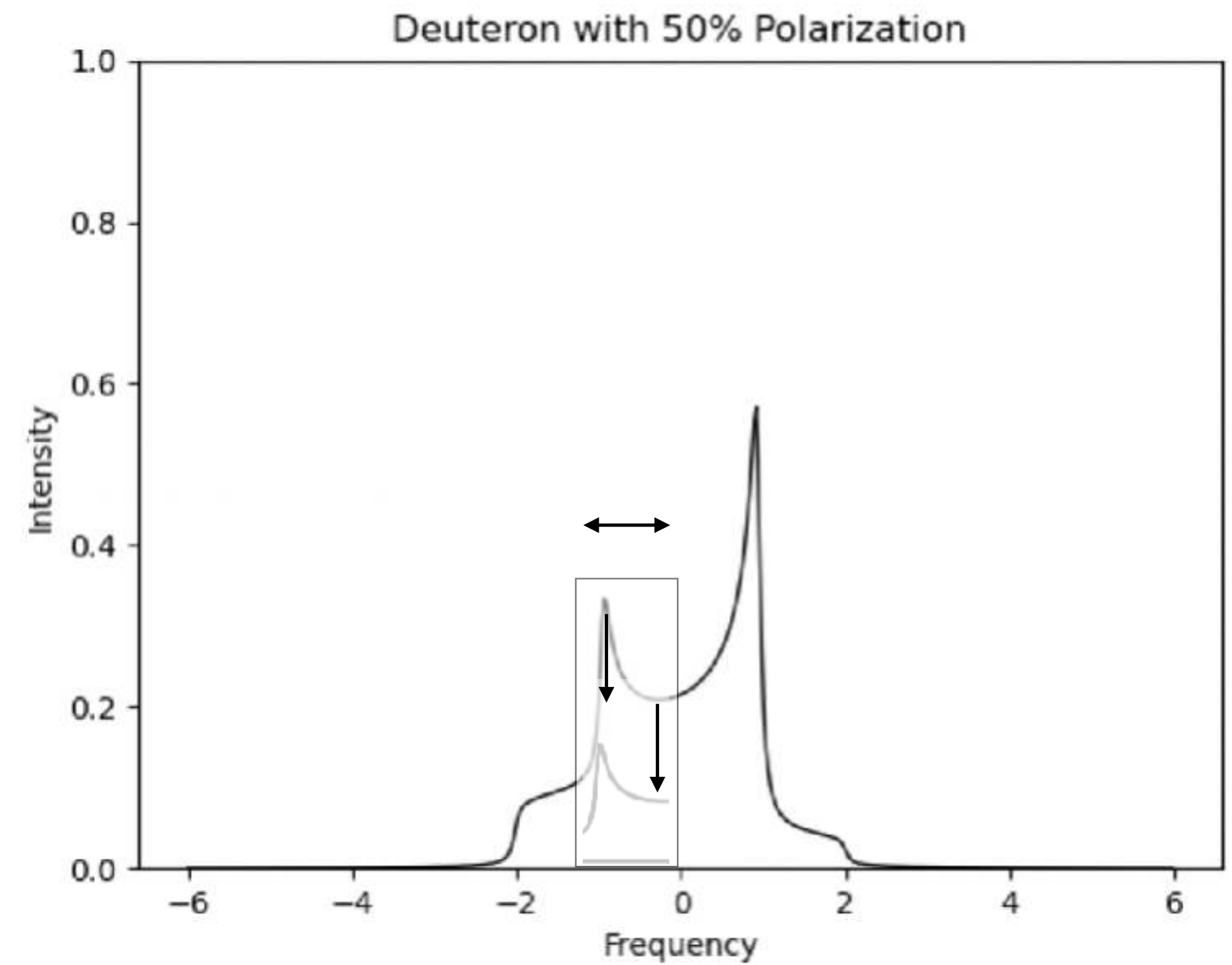
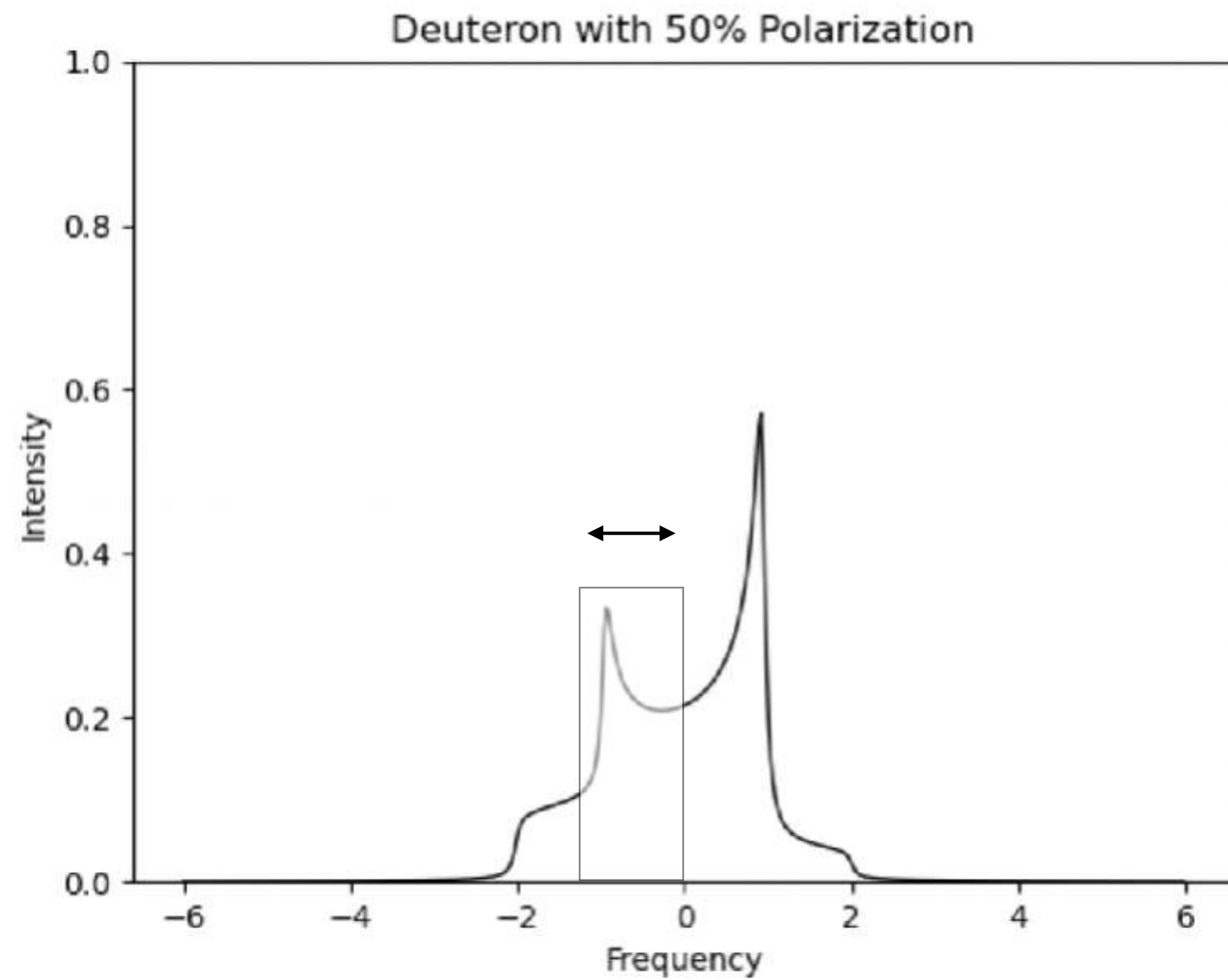

# Spin Temperature Consistency or strategic depolarization

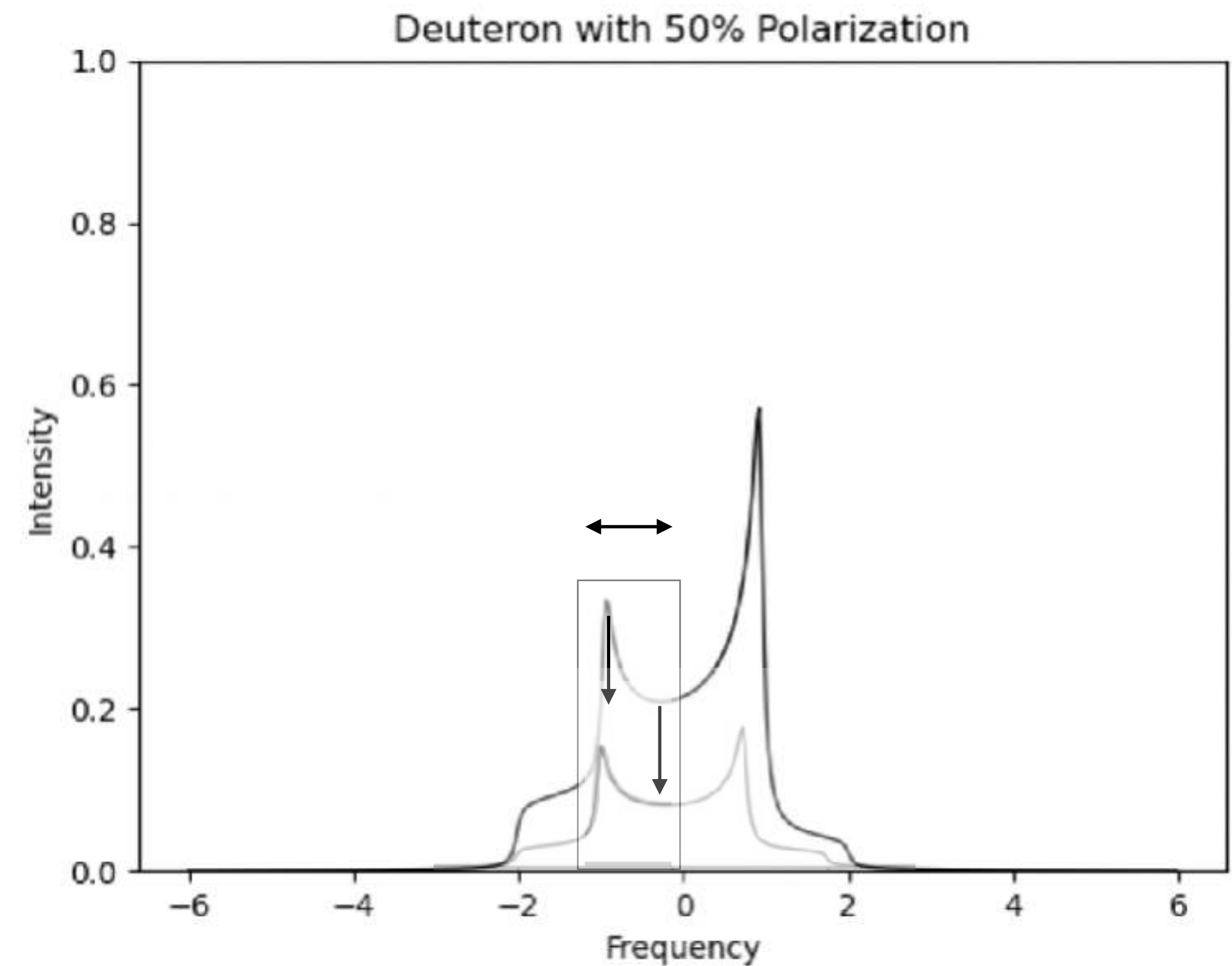
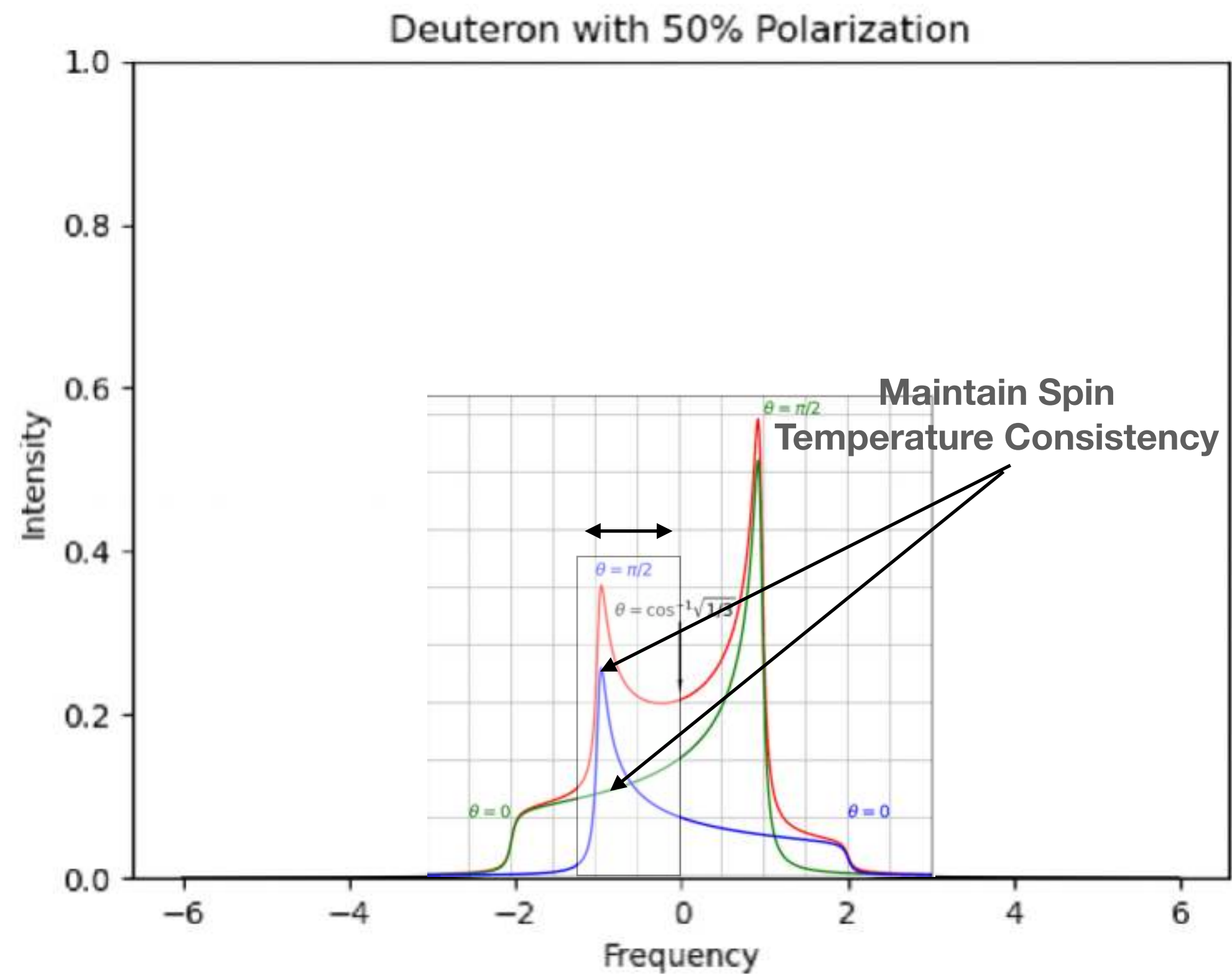

**Principle: If you know the sum you know the difference**



# Rate Response

Or why you can get rid of models

$$A_{lost} = \frac{1}{2} A_{gained}$$

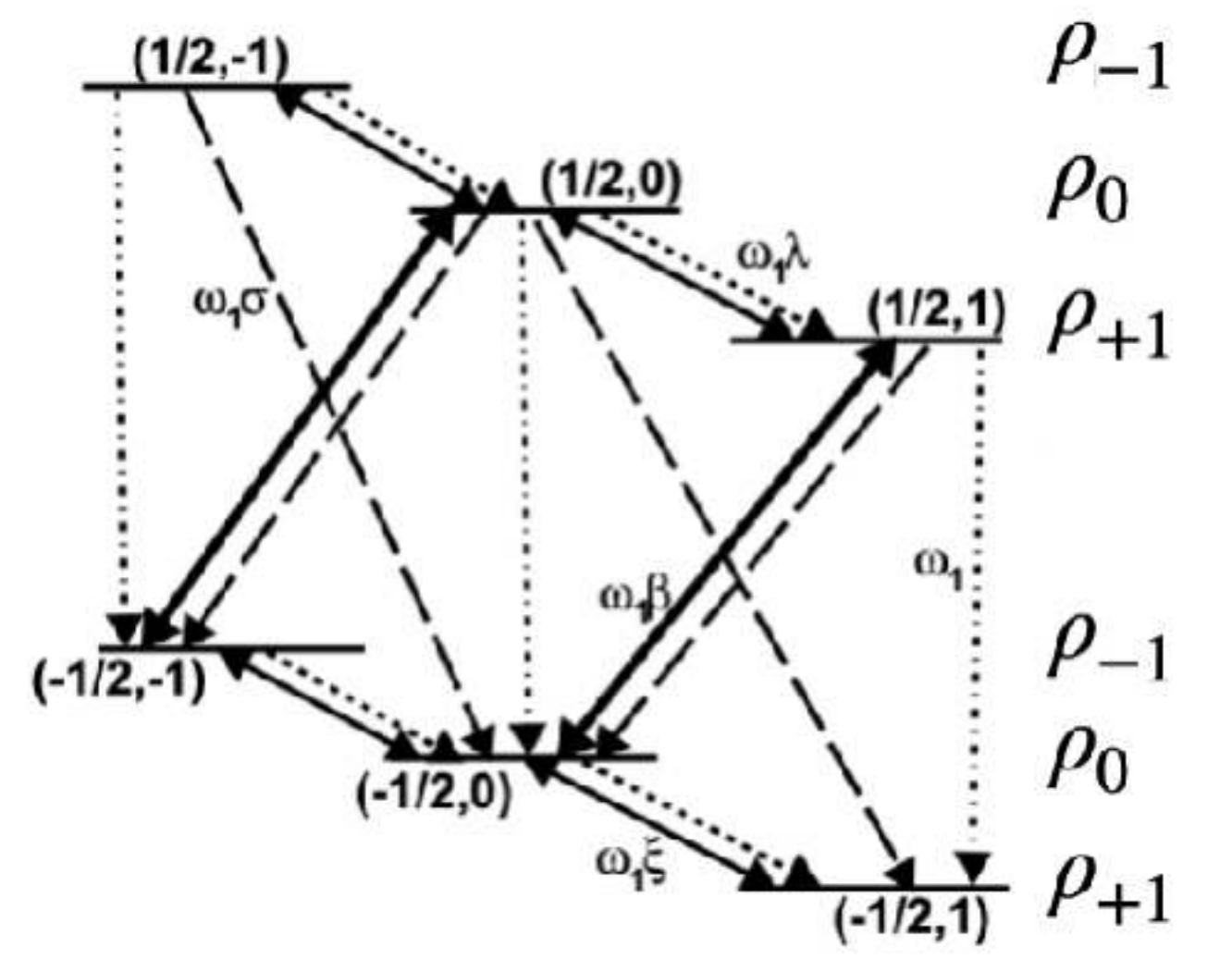

$$I_-(-\mathcal{R}) = C(\rho_0 - \rho_-)$$

$$I_+(-\mathcal{R}) = C(\rho_+ - \rho_0)$$

$$I_-(-\mathcal{R}) - \dot{I}_-(-\mathcal{R})$$

$$I_+(-\mathcal{R}) - \dot{I}_0(-\mathcal{R})$$

$$= C[(\rho_0 - \xi\rho_0) - (\rho_- + \xi\rho_0)]$$

$$= C[(\rho_+ - \xi\rho_+) - (\rho_0 + \xi\rho_+)]$$

$$= C[(\rho_0 - \rho_-) - 2\xi\rho_0]$$

$$= C[(\rho_+ - \rho_0) - 2\xi\rho_+]$$

$$\dot{I}_-(-\mathcal{R}) = -2C\xi\rho_0$$

$$\dot{I}_+(-\mathcal{R}) = -2C\xi\rho_+$$

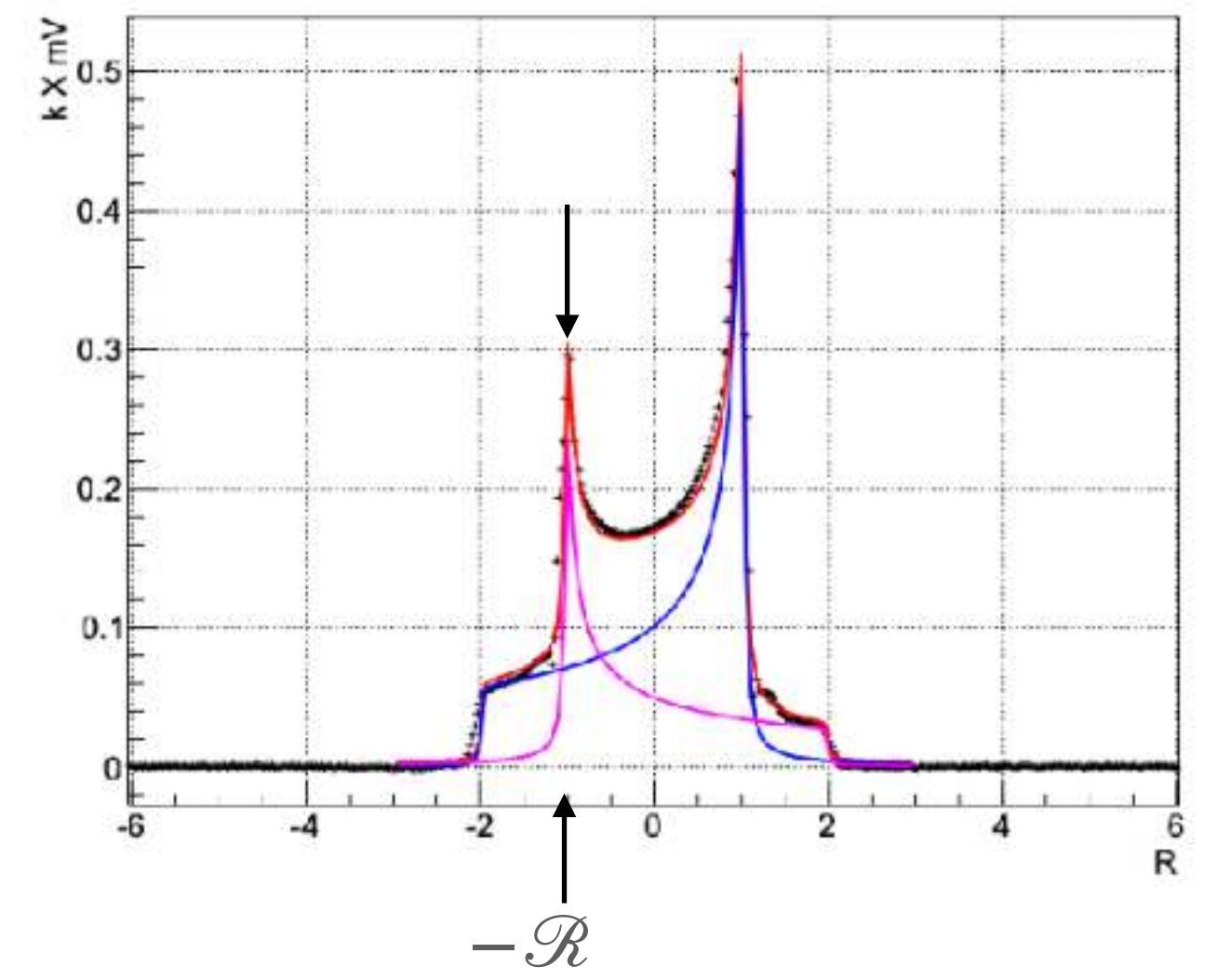

# Rate Response

Or why you can get rid of models

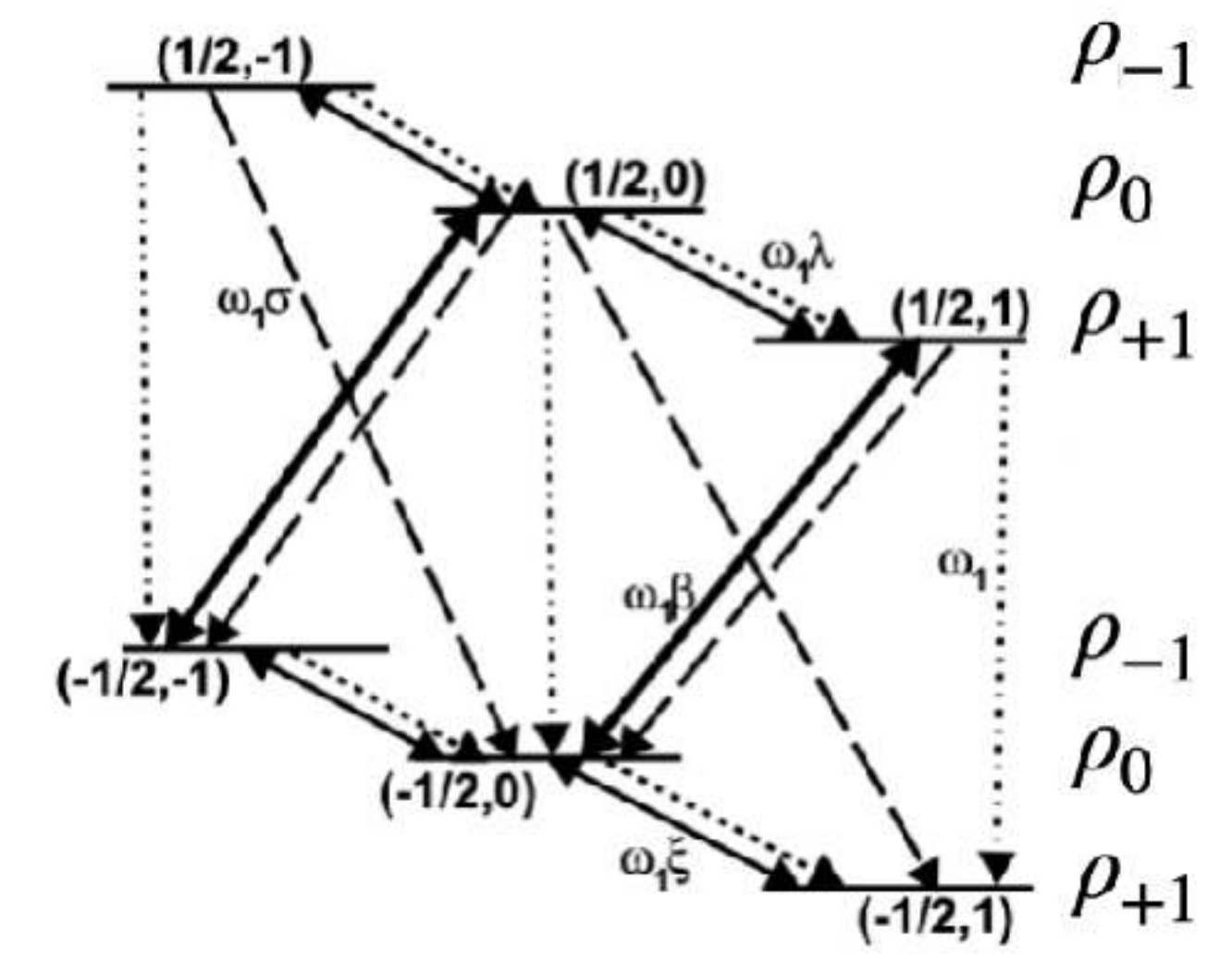

$$I_-(-\mathcal{R}) = C(\rho_0 - \rho_-)$$

$$I_+(-\mathcal{R}) = C(\rho_+ - \rho_0)$$

$$I_+(\mathcal{R}) + \dot{I}_+(\mathcal{R})$$

$$I_-(\mathcal{R}) + \dot{I}_-(\mathcal{R})$$

$$= C[(\rho_+) - (\rho_0 - \xi\rho_0)]$$

$$= C[(\rho_0 + \xi\rho_+) - (\rho_-)]$$

$$= C[(\rho_+ - \rho_0) + \xi\rho_0]$$

$$= C[(\rho_0 - \rho_-) + \xi\rho_+]$$

$$\dot{I}_+(\mathcal{R}) = C\xi\rho_0$$

$$\dot{I}_-(\mathcal{R}) = C\xi\rho_+$$

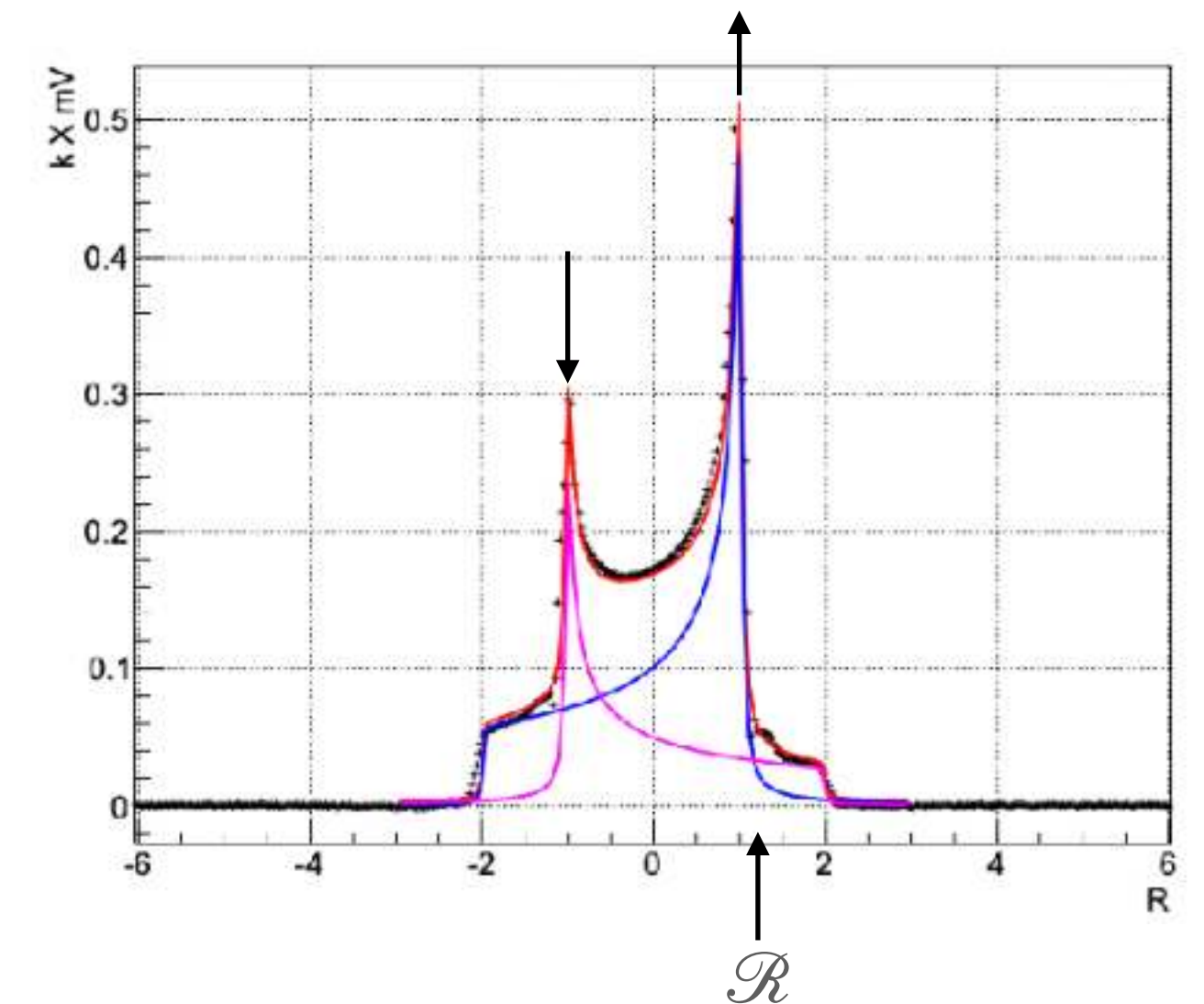

# Rate Response

Or why you can get rid of models

$$\dot{I}_-(-\mathcal{R}) = -2C\xi\rho_0$$

$$\dot{I}_+(\mathcal{R}) = C\xi\rho_0$$

$$\dot{I}_-(-\mathcal{R}) = -\frac{1}{2}\dot{I}_+(\mathcal{R})$$

$$\dot{I}_+(-\mathcal{R}) = -2C\xi\rho_+$$

$$\dot{I}_-(\mathcal{R}) = C\xi\rho_+$$

$$\dot{I}_+(-\mathcal{R}) = -\frac{1}{2}\dot{I}_-(\mathcal{R})$$

$$A_{lost} = \frac{1}{2}A_{gained}$$

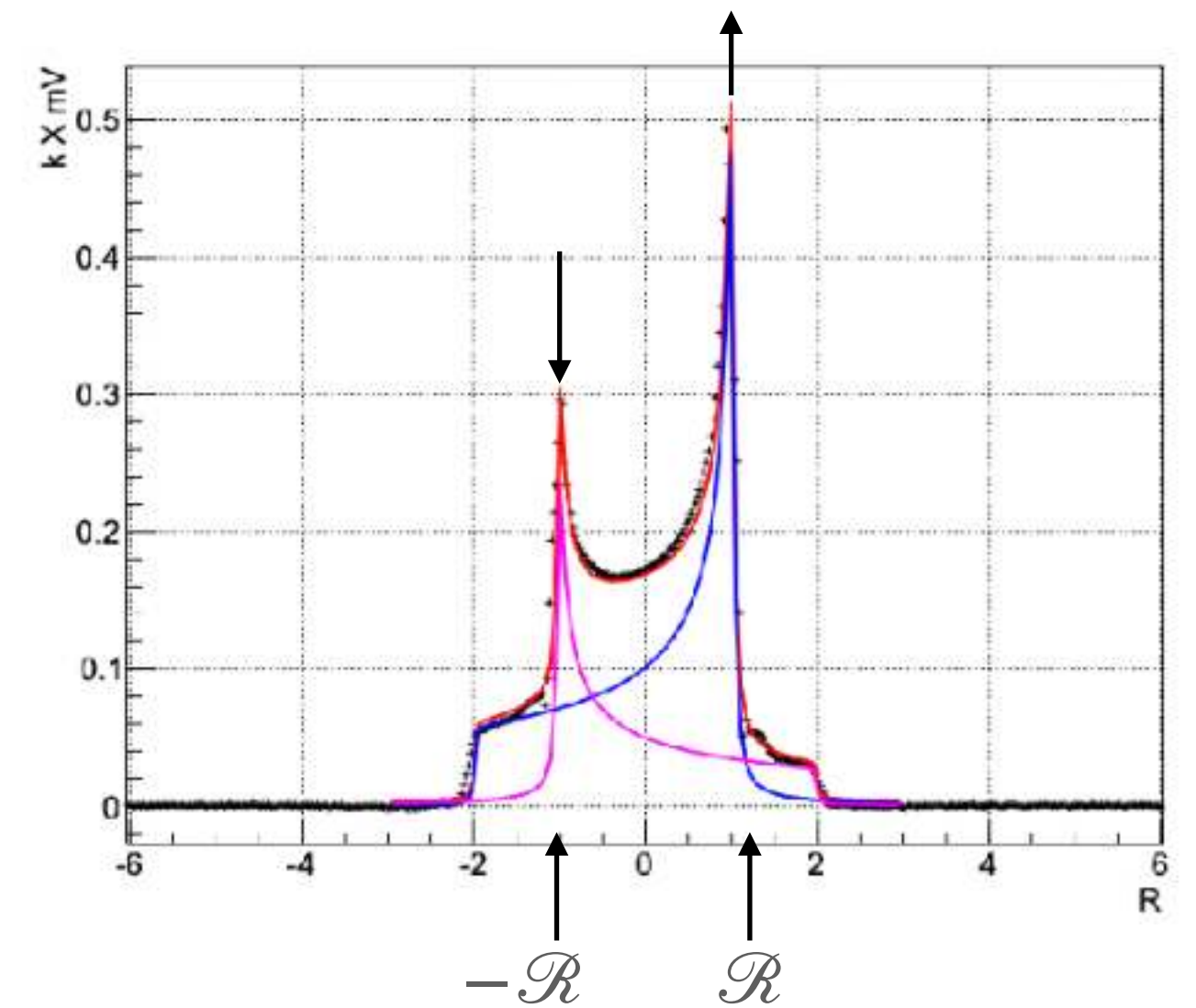
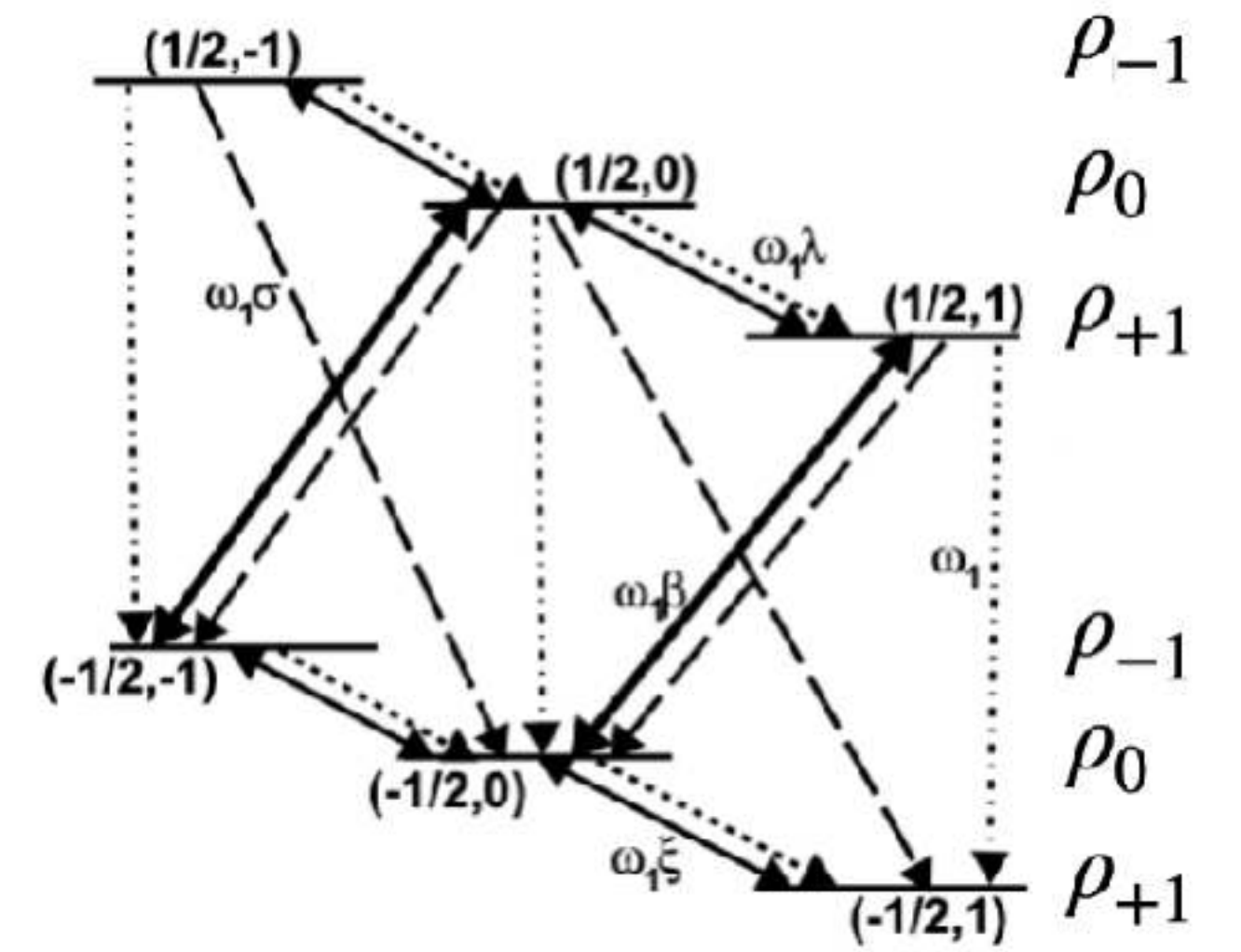

# Putting These Conditions Together

## Simple Measuring Tools

- The difference (Q) in intensities can be easily calculated using Boltzmann
- Apply  $A_{lost} = \frac{1}{2} A_{gained}$
- Configure for any vector polarization and the particular RF region
- You're Done!!

Universally True  
Any lineshape  
Any material

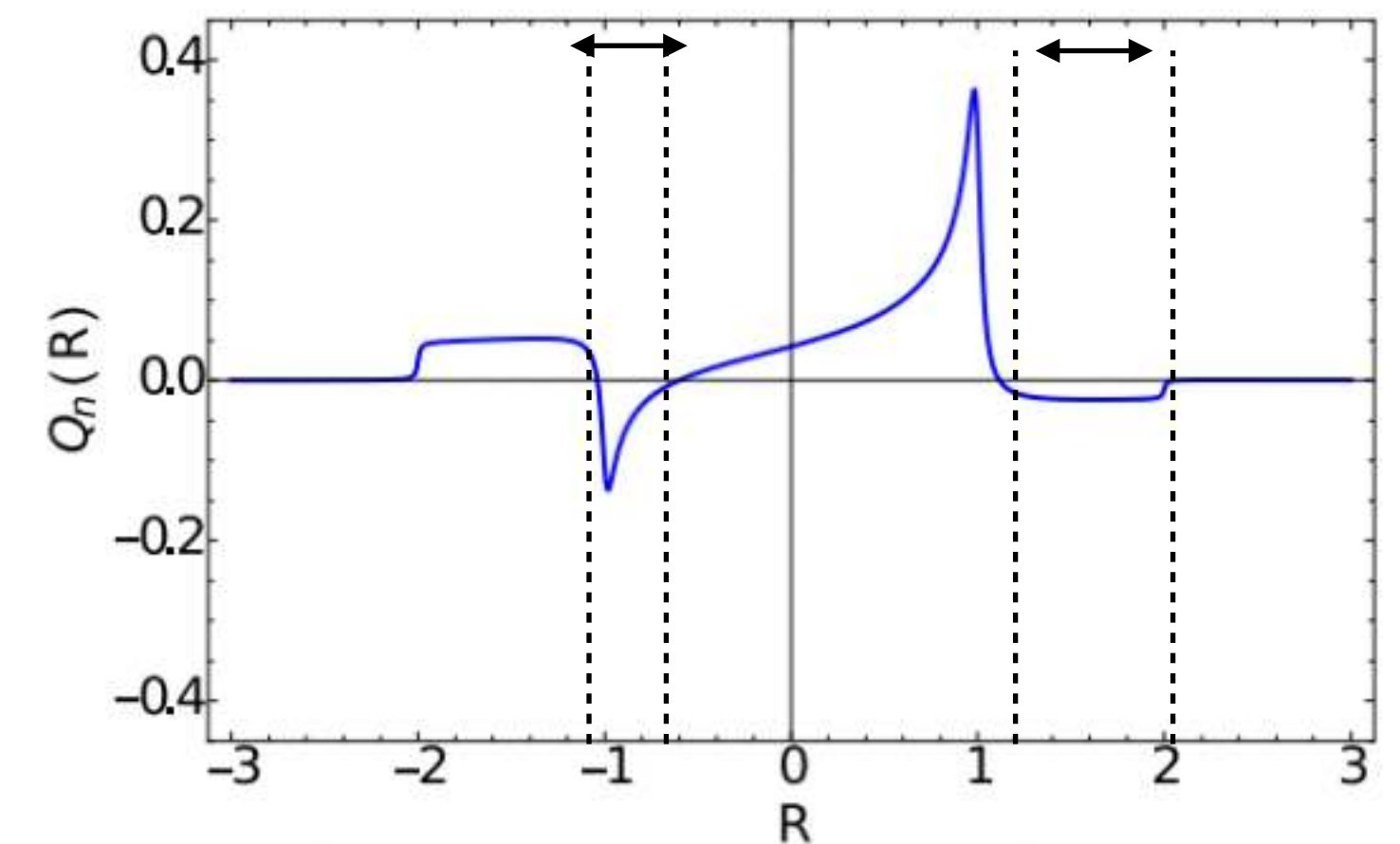
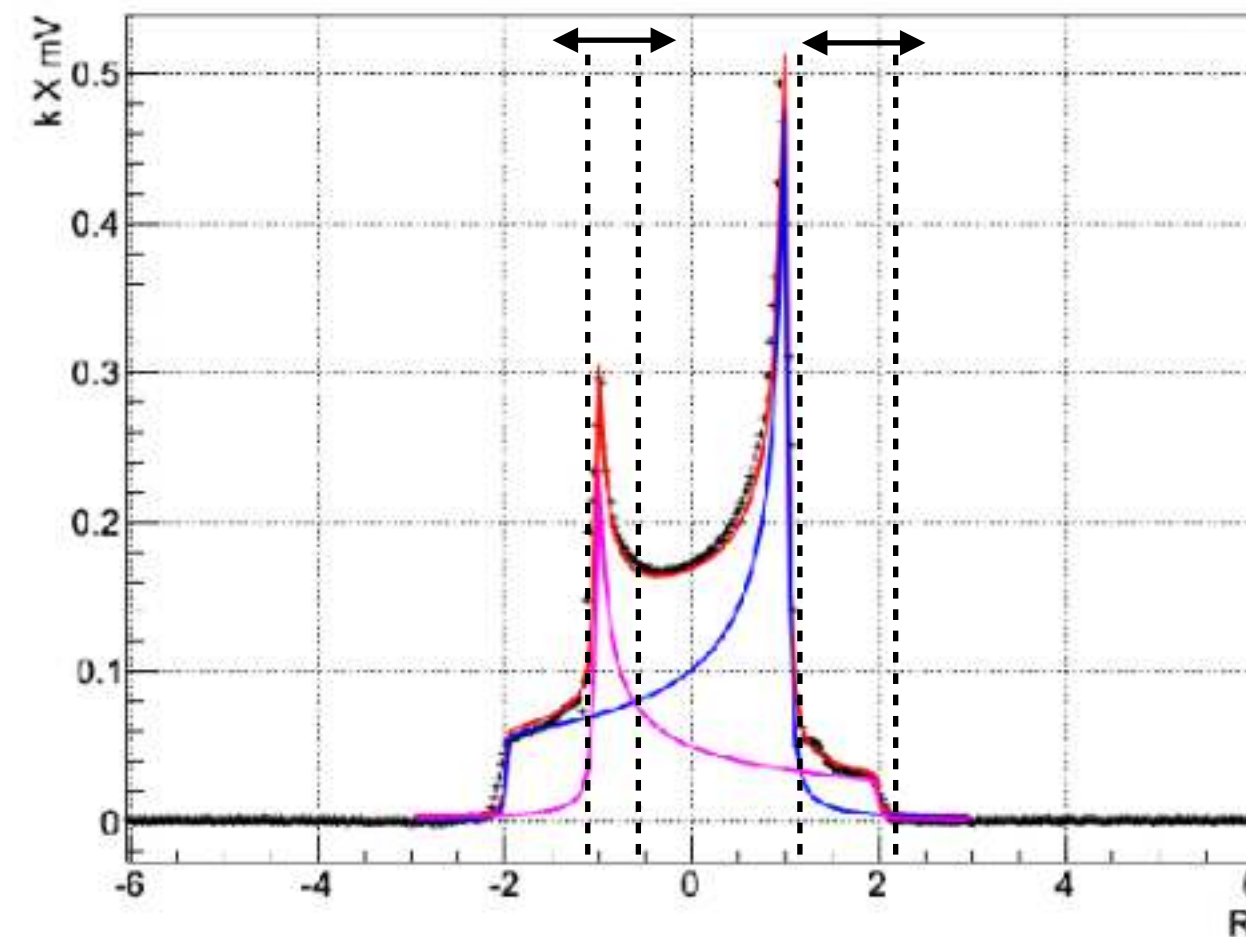

# Caveats

## What is exact and what is approximation

- Everything just laid out is exact for any polarization mechanism, any line shape, and any material and so **not model dependent**
- Everything just laid out is in reference to longitudinal (spin-lattice) relaxation pathways and not transverse (spin-spin, like spin diffusion)
  - To take into account the transverse relaxation pathways one needs to fit the hole using a Voigt (convolution of Gaussian and Lorentzian)
  - These fits are sensitive to Q-factor of coil, degree of tuning and matching of RF circuit, amplification parameters, and transverse relaxation of material

# Addressing Transverse Pathways

## Voigt Profile

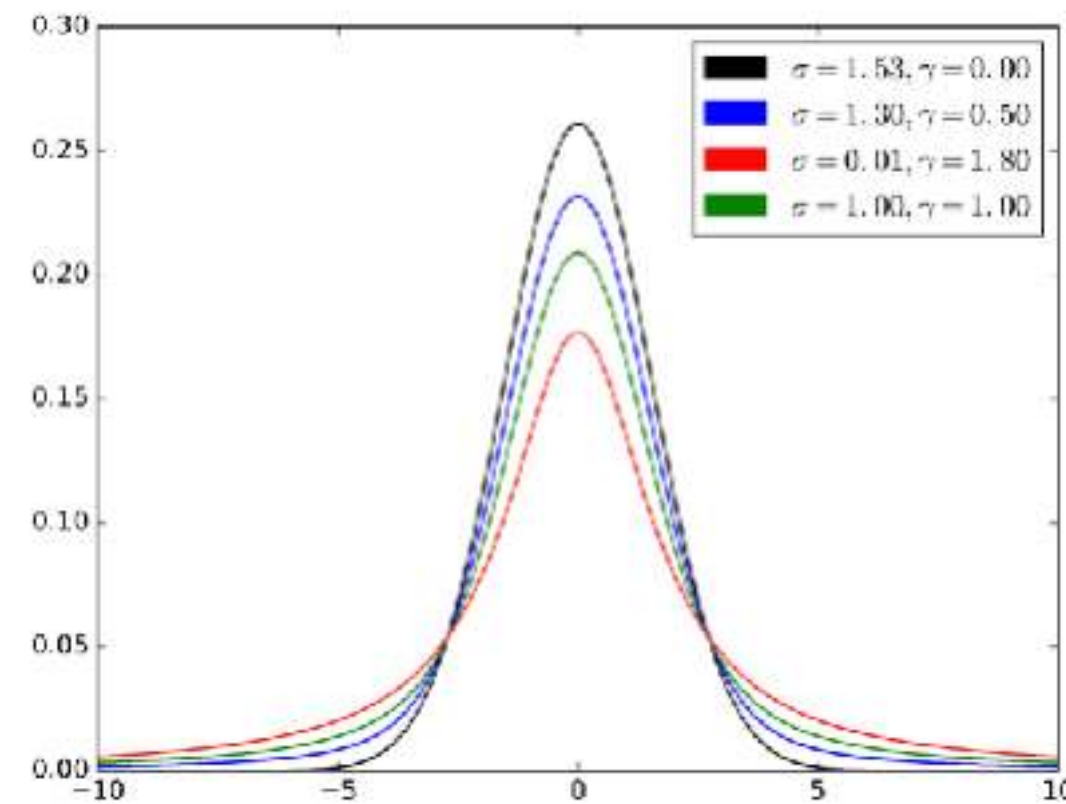

$$V(x; \sigma, \gamma) \equiv \int_{-\infty}^{\infty} G(x'; \sigma) L(x - x'; \gamma) dx'$$

$$G(x; \sigma) \equiv \frac{e^{-x^2/(2\sigma^2)}}{\sigma\sqrt{2\pi}}$$

$$L(x; \gamma) \equiv \frac{\gamma}{\pi(x^2 + \gamma^2)}$$

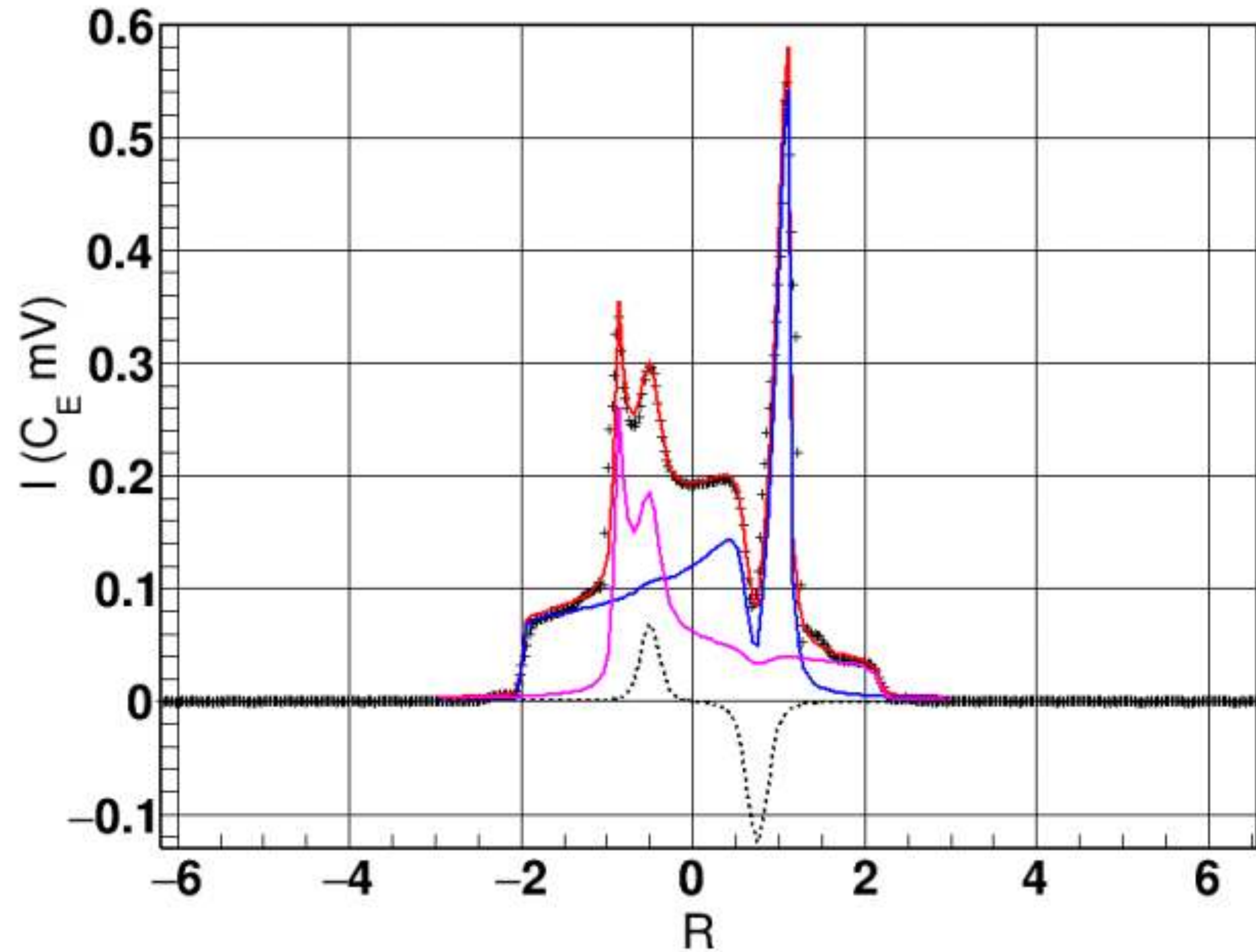

# Uncertainty Propagation

$$\left(\frac{\delta C_{TE}}{C_{TE}}\right)^2 = \left(\frac{\delta P_{TE}}{P_{TE}}\right)^2 + \left(\frac{\delta A_{TE}}{A_{TE}}\right)^2$$

$$\frac{\delta P_E}{P_E} = \left[ \left(\frac{\delta P_{TE}}{P_{TE}}\right)^2 + \left(\frac{\delta A_{TE}}{A_{TE}}\right)^2 + \left(\frac{\delta S_{TE}}{S_{TE}}\right)^2 + \left(\frac{\delta A_E}{A_E}\right)^2 + \left(\frac{\delta S_E}{S_E}\right)^2 + \left(\frac{\delta G}{G}\right)^2 \right]^{1/2}$$

- 1  $A_{TE}$  - Relative uncertainties in area acquired during TE
- 2  $S_{TE}$  - Measurement limitation during TE
- 3  $S_E$  - Systematic variation in enhanced signal
- 4  $G$  - Error from gain

## Modern Uncertainty Measurement

- Produce a simulated signal
- Extract using modern measurement tools
- Minimize deviation

(#)	Type	Source	Error (%)
(1)	$S_{TE}$	$\Delta T$	1.45
(2)	$A_{TE}$	$\Delta A_{TE}$	1.61
(3)	$A_{TE}$	$\Delta A_{fit}$	0.75
(4)	$S_E$	$K_B$	0.50
(5)	$S_E$	$\Delta V_Q$	0.75
(6)	$S_E$	NMR-tune	0.47
(7)	$S_E$	$\Delta B_{drift}$	0.25
(8)	$G$	$\Delta V_{Yule}$	0.10
(9)	-	$\Delta \bar{P}_{rms}$	0.50

NIM A 728 (2013) 133-144

### Additional Contributions (Steady-State)

$$\delta I_{\pm} = \sqrt{(\delta C)^2 + (\delta A_{\chi^2})^2 + (\delta A_{\partial t})^2}$$

- $(\delta C)$  Standard Contributions from above
- $(\delta A_{\chi^2})$  Variation in area over covariance matrix minimization
- $(\delta A_{\partial t})$  NMR measurement limitations with respects to relaxation rate

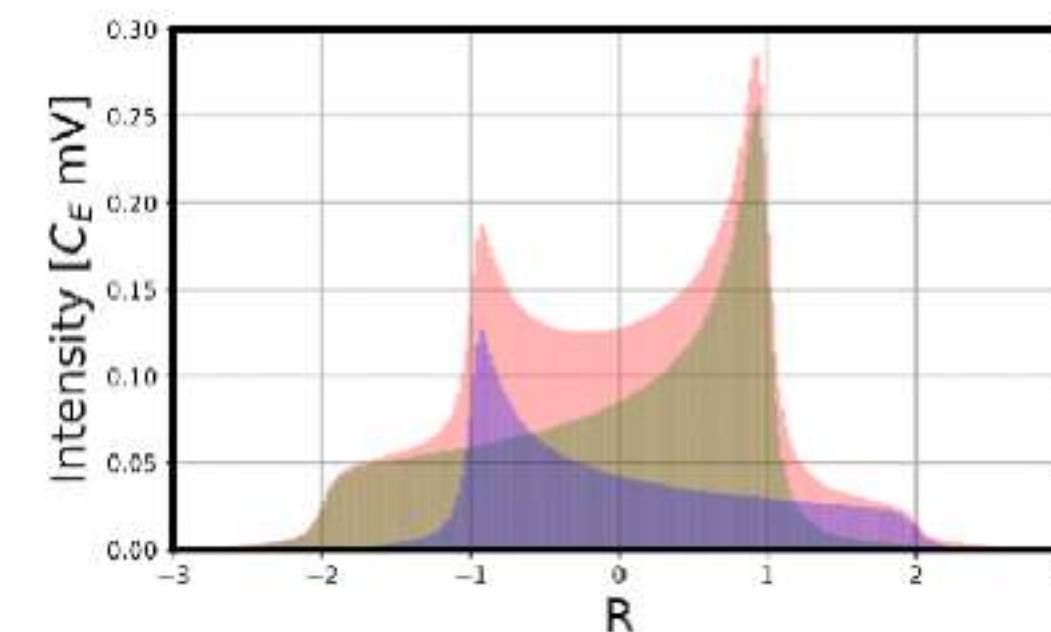

# Modern Measurement Tools

## Specialized for application

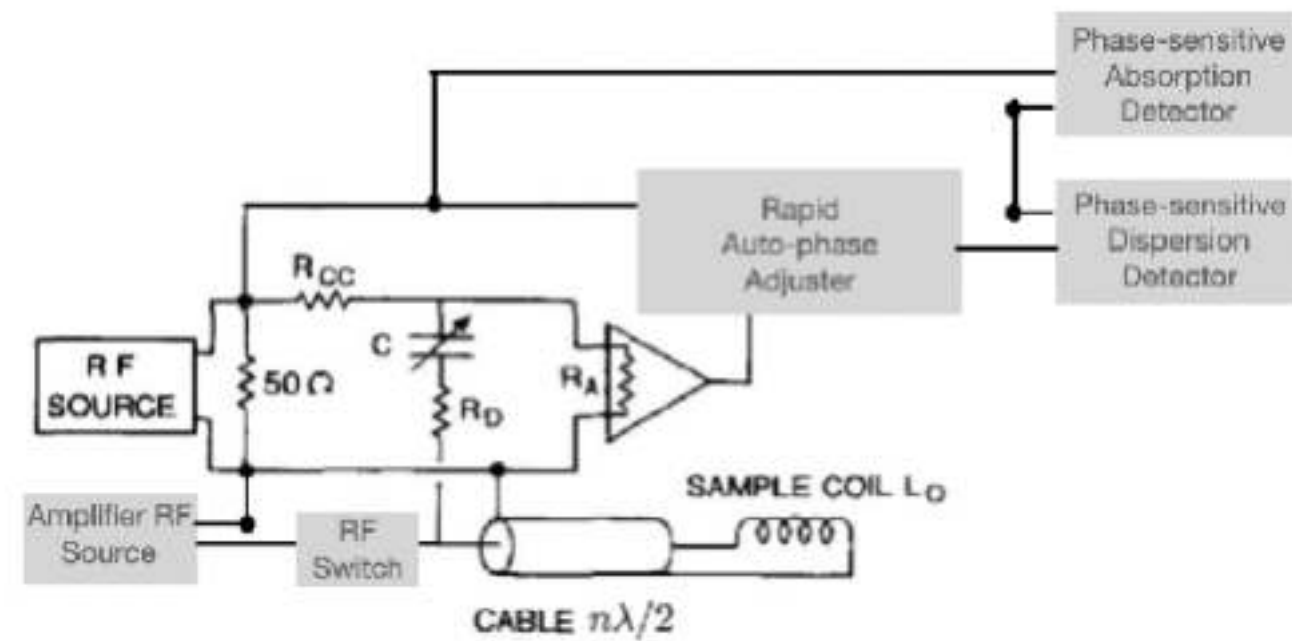

With this design, the reference signal is supplied to the mixer while being modulated rapidly (~MHz) using a programmable auto-phase adjuster, from a dedicated phase shifter. The reference is then broken into the real and imaginary parts of the signal and passed to the analyzer which uses fast signal integration to produce 1000 phase-shifted measurements and a CW dispersion measurement simultaneously. This information is then sent to the RF controls to make the polarization measurements and adjust the RF modulation across the frequency domain to continuously tune and optimize the signal.

UVA has prototyped this type of system and is presently studying the required design parameters and determining how best to fully integrate this new system into modered DAQ and monitoring electronics. We are also looking into how to attract funds to build this system.

- Pass1: Measure single sweep
- Analyze signal and match to optimized line
- Pass2: Apply required power RF profile in domain
- Iterate

Instrumentation Advancement

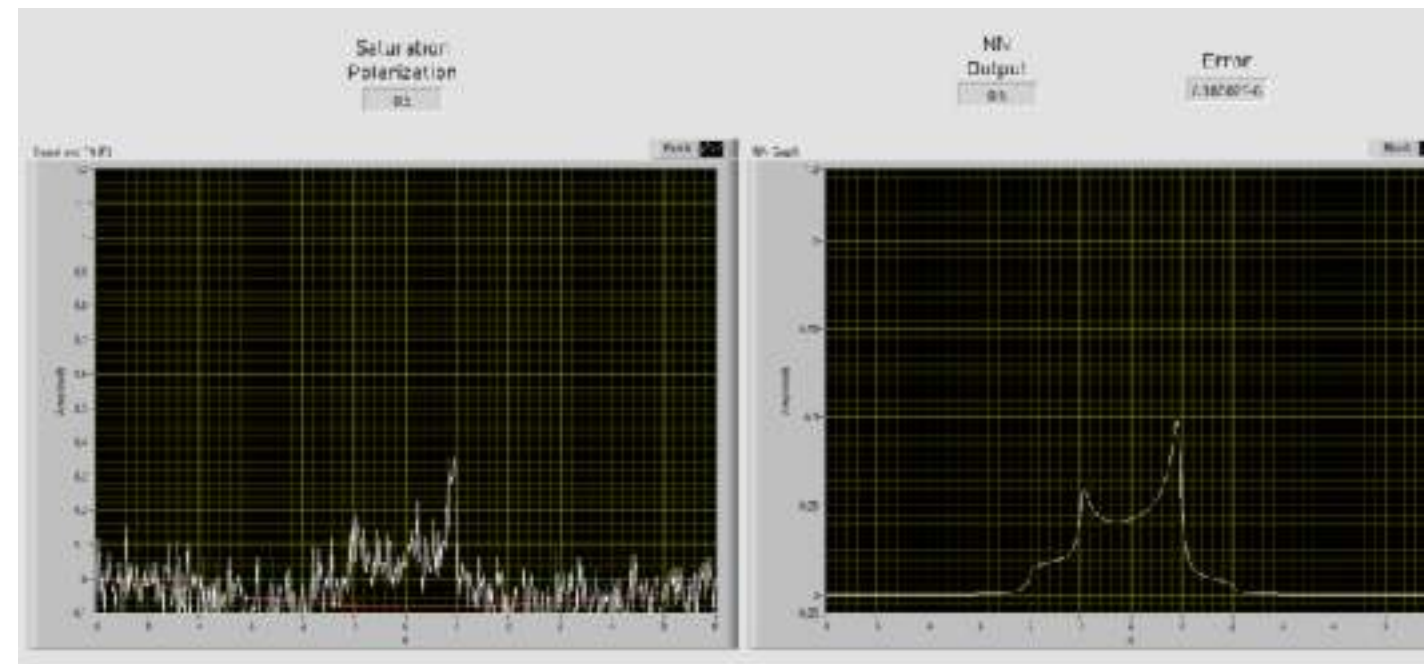
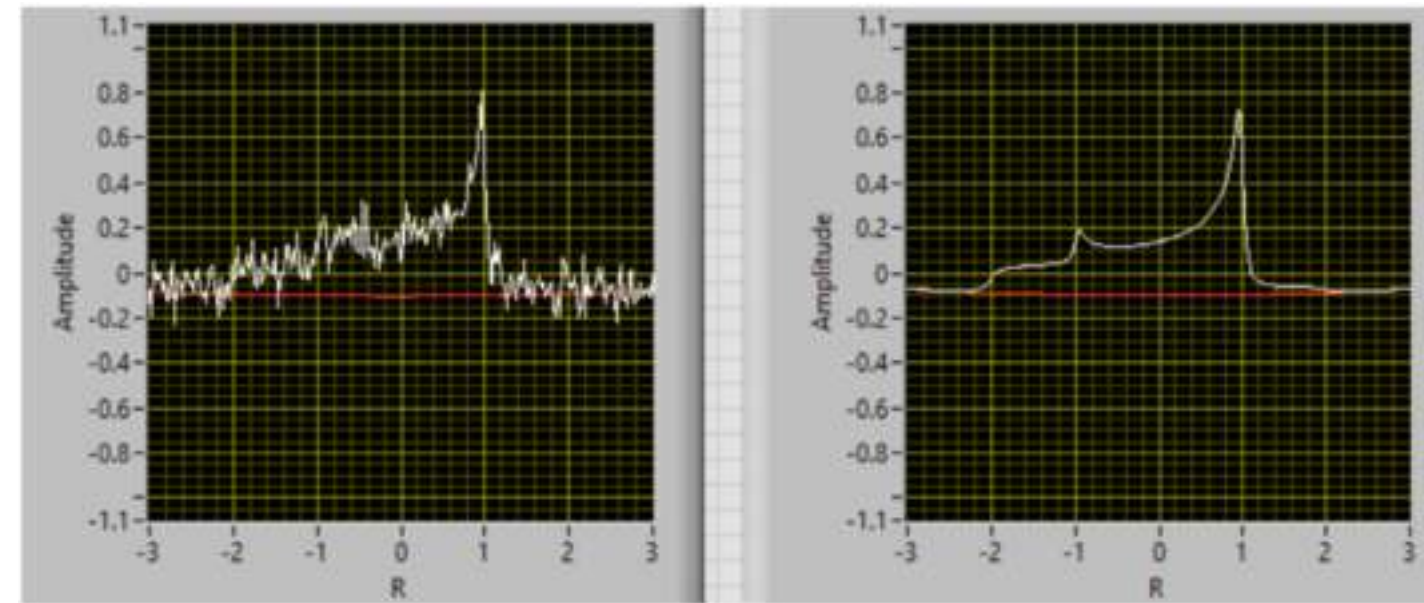

2% relative @ 6% full scale noise

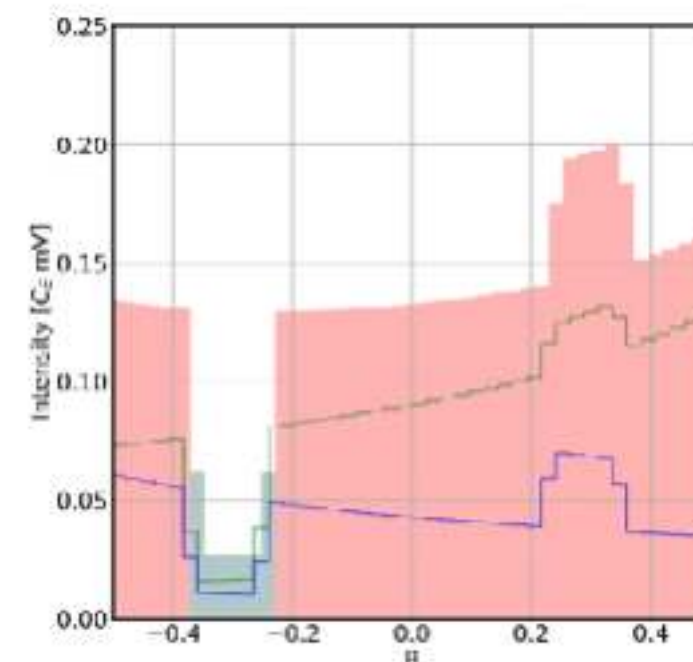

Q-Meter Simulation

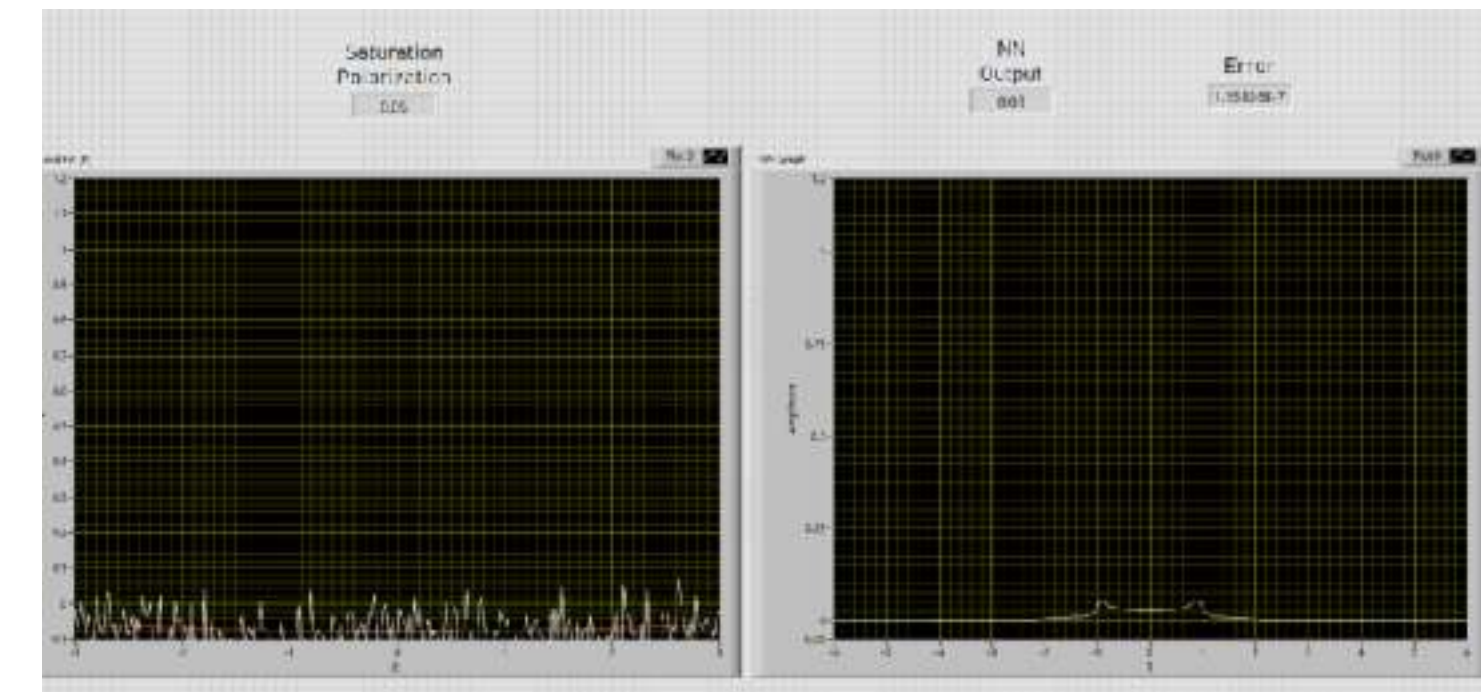
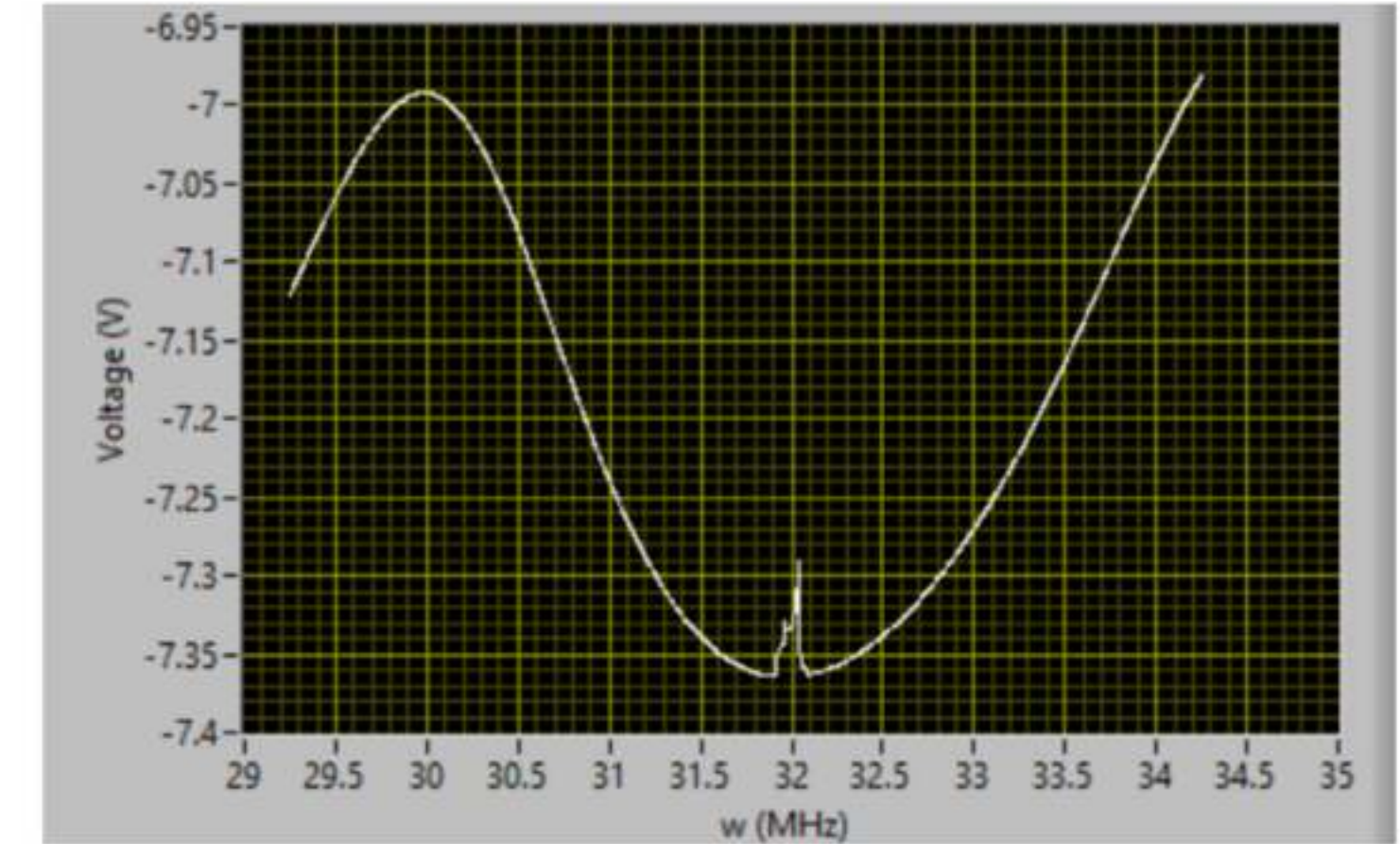

ANN with NMR

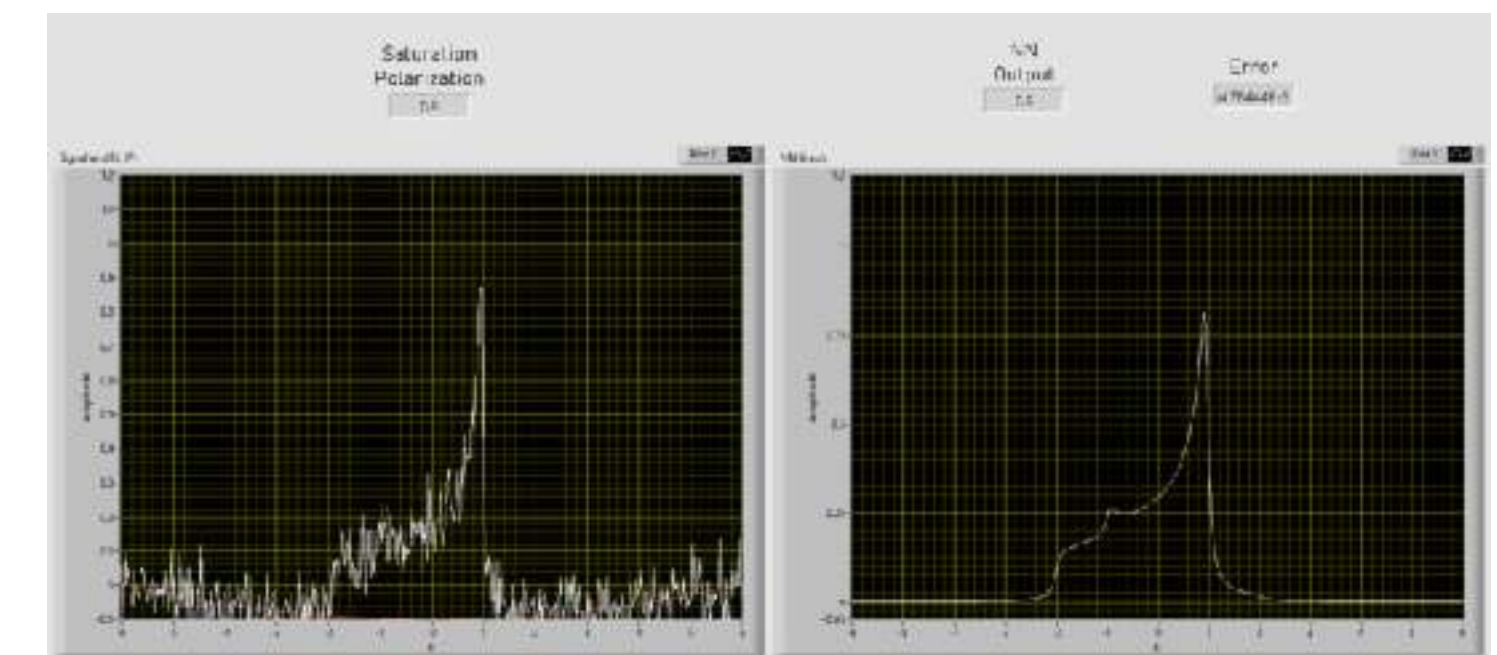

Software Advancement



# Measurements of Tensor Enhancement

## Experimental results (all with irradiated d-Butanol)

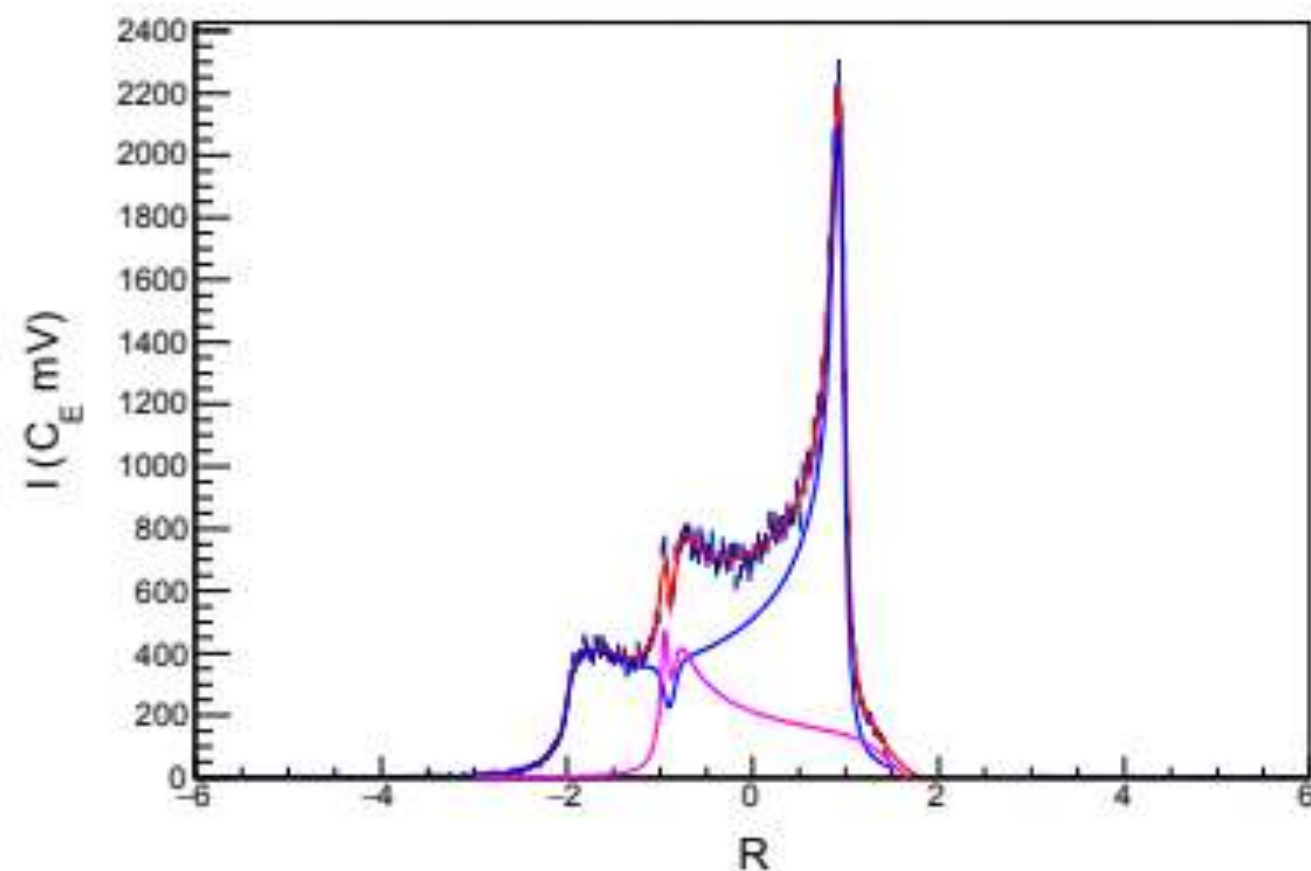
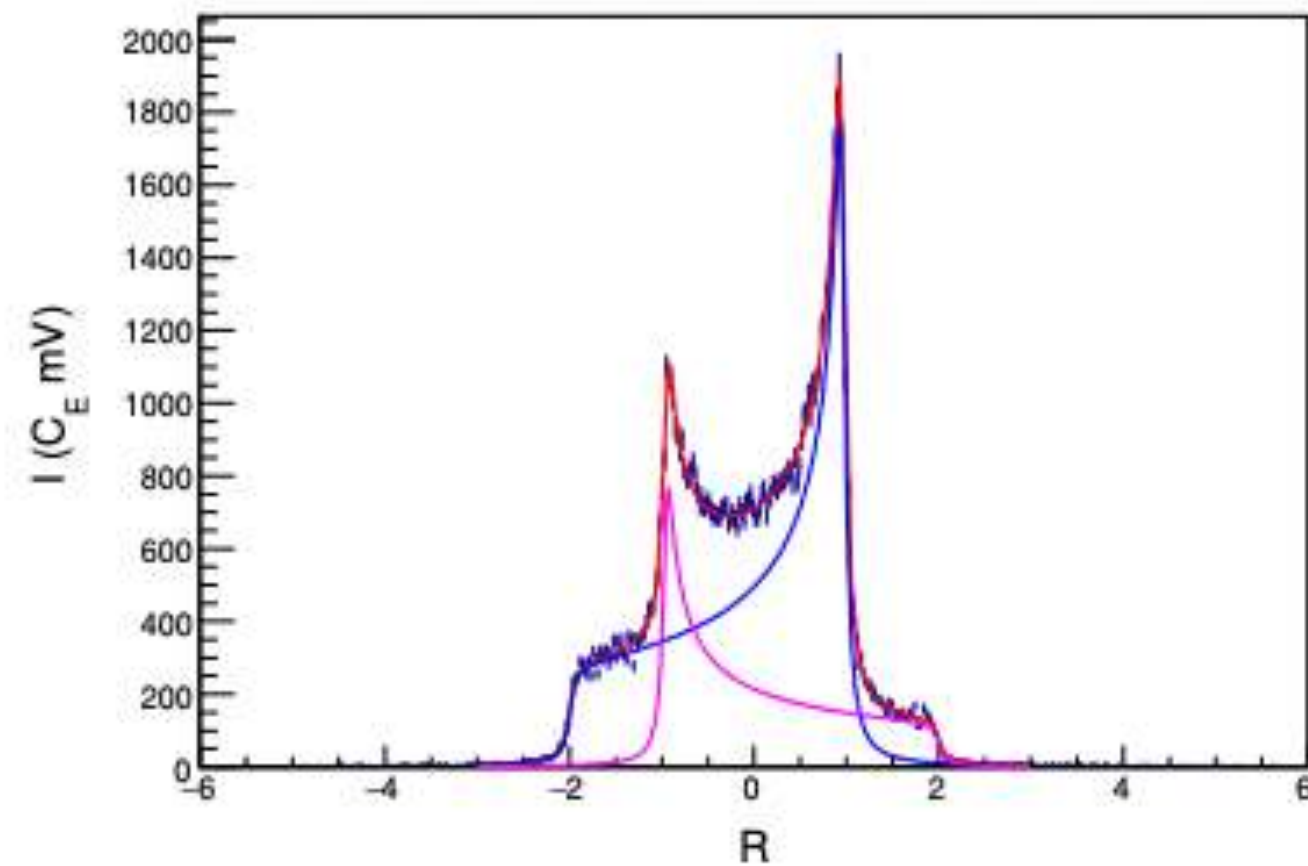

ss-RF Enhanced Measurements					
Peak (MHz)	Amp (mV)	Pedestal (MHz)	Amp (mV)	$P_{zz}$ (%)	Error (%)
32.62(0.000)	20	32.85(0.015)	70	26.7	5.4
32.63(0.015)	30	32.85(0.020)	40	28.8	5.7
32.64(0.015)	30	32.84(0.025)	40	29.4	7.2
32.64(0.015)	25	32.83(0.035)	20	26.5	6.8
32.64(0.015)	20	32.85(0.035)	70	30.3	7.8
32.64(0.020)	20	32.85(0.025)	40	27.5	4.7
32.64(0.015)	40	32.88(0.055)	50	31.1	8.5

NIM A 981, (2020), 164504

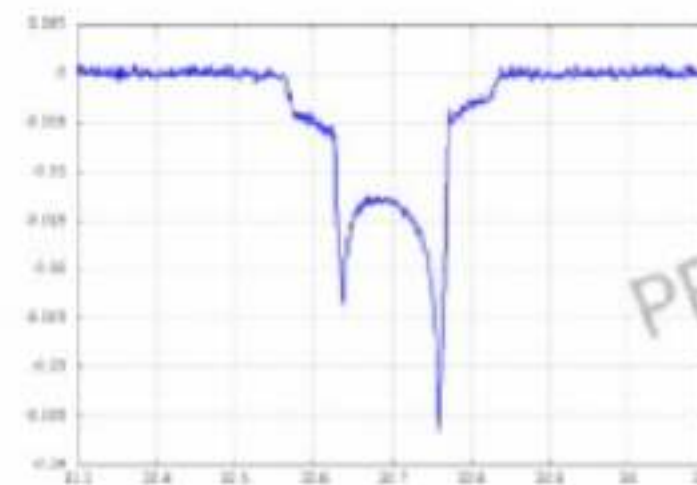

before

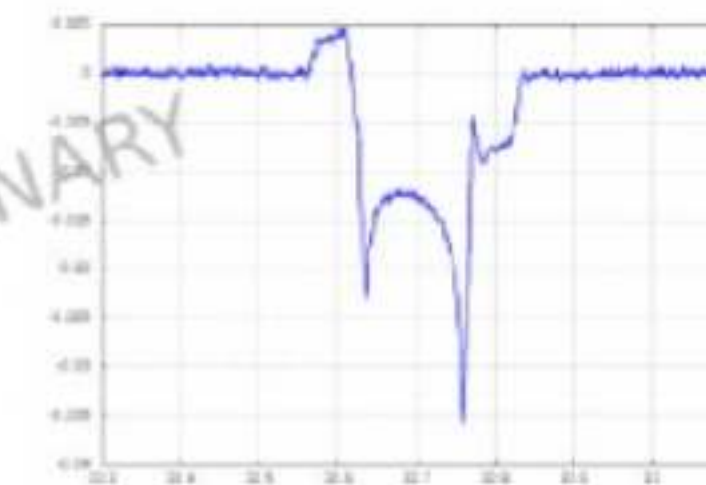

after

PRELIMINARY

# Charge-3

## Change as a Function of Dose

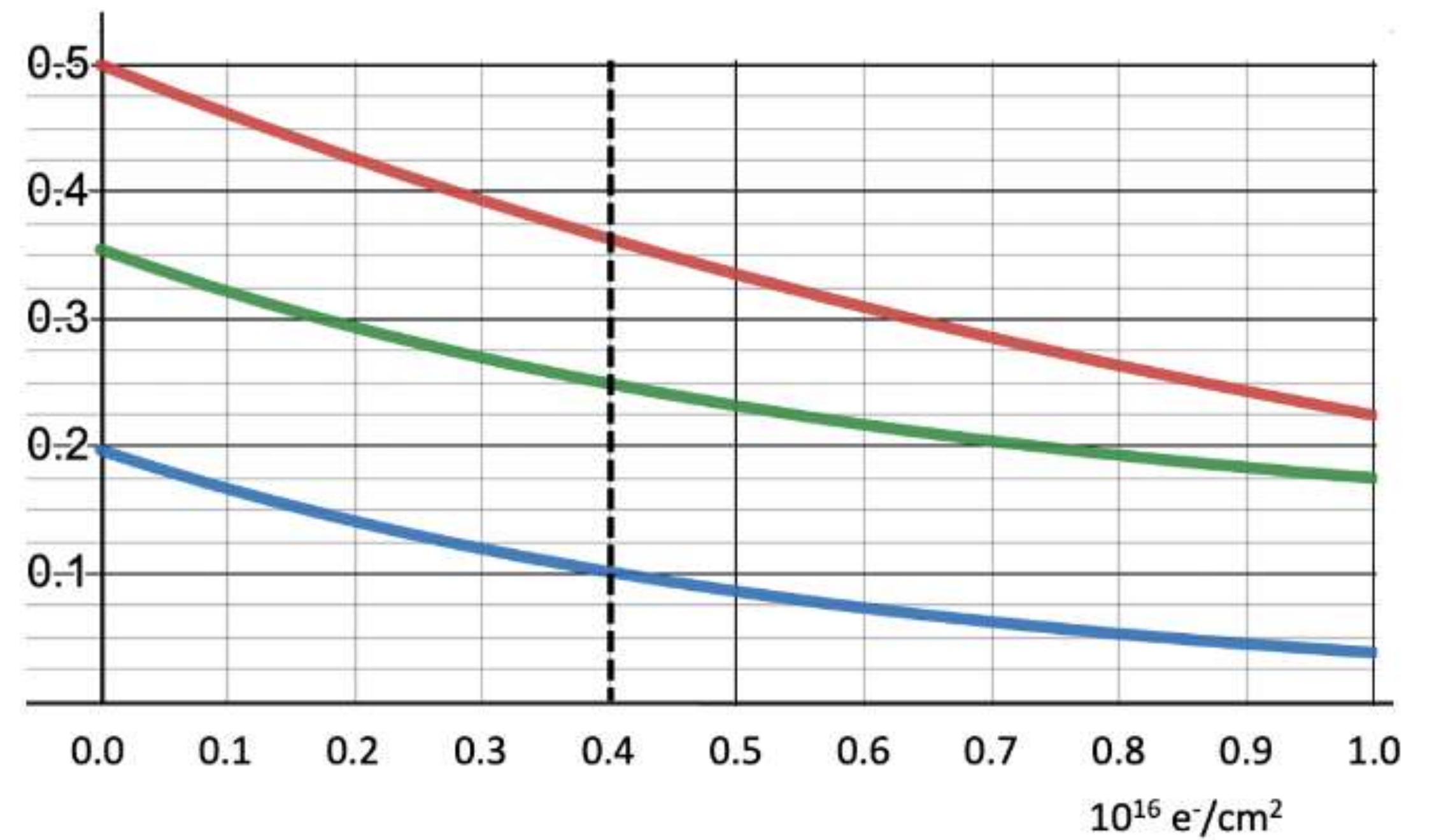
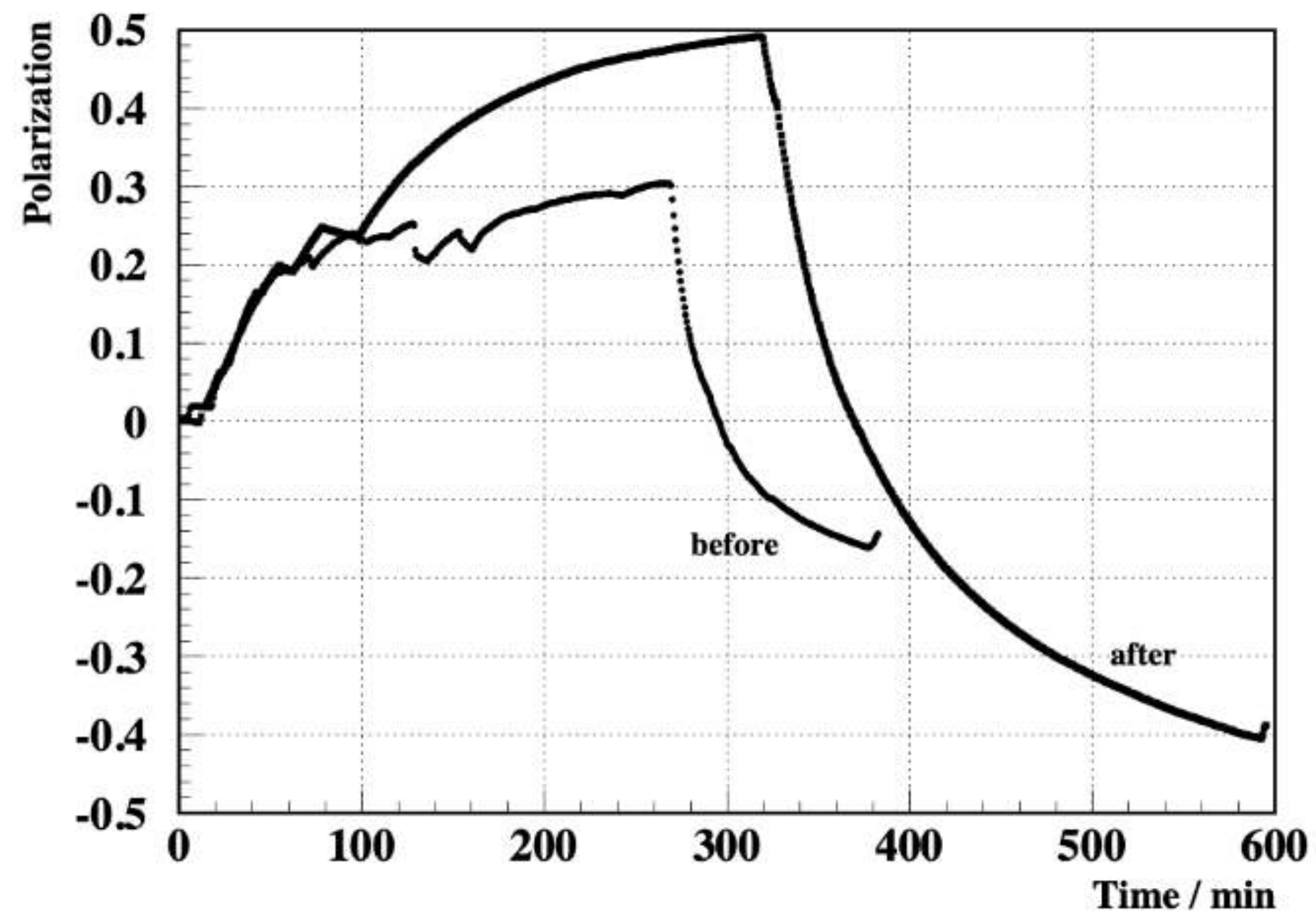
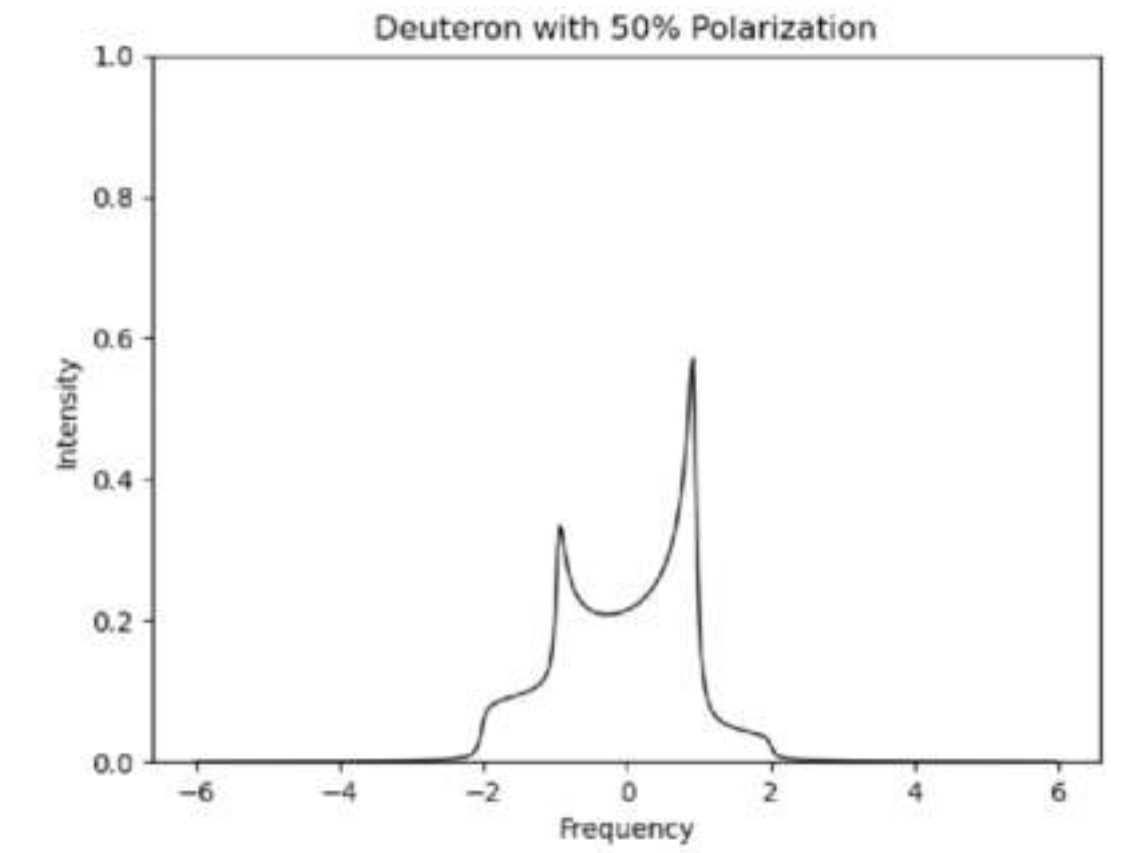
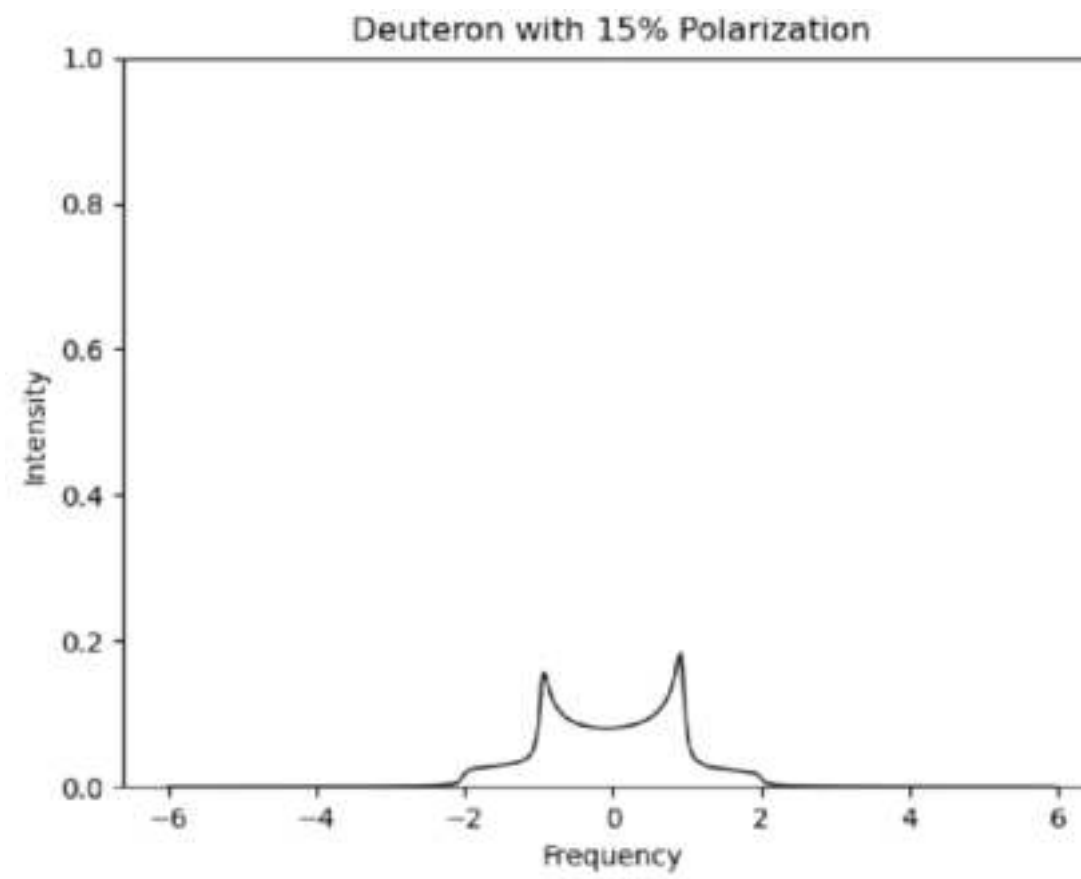

# Charge-3

## Change as a Function of Dose

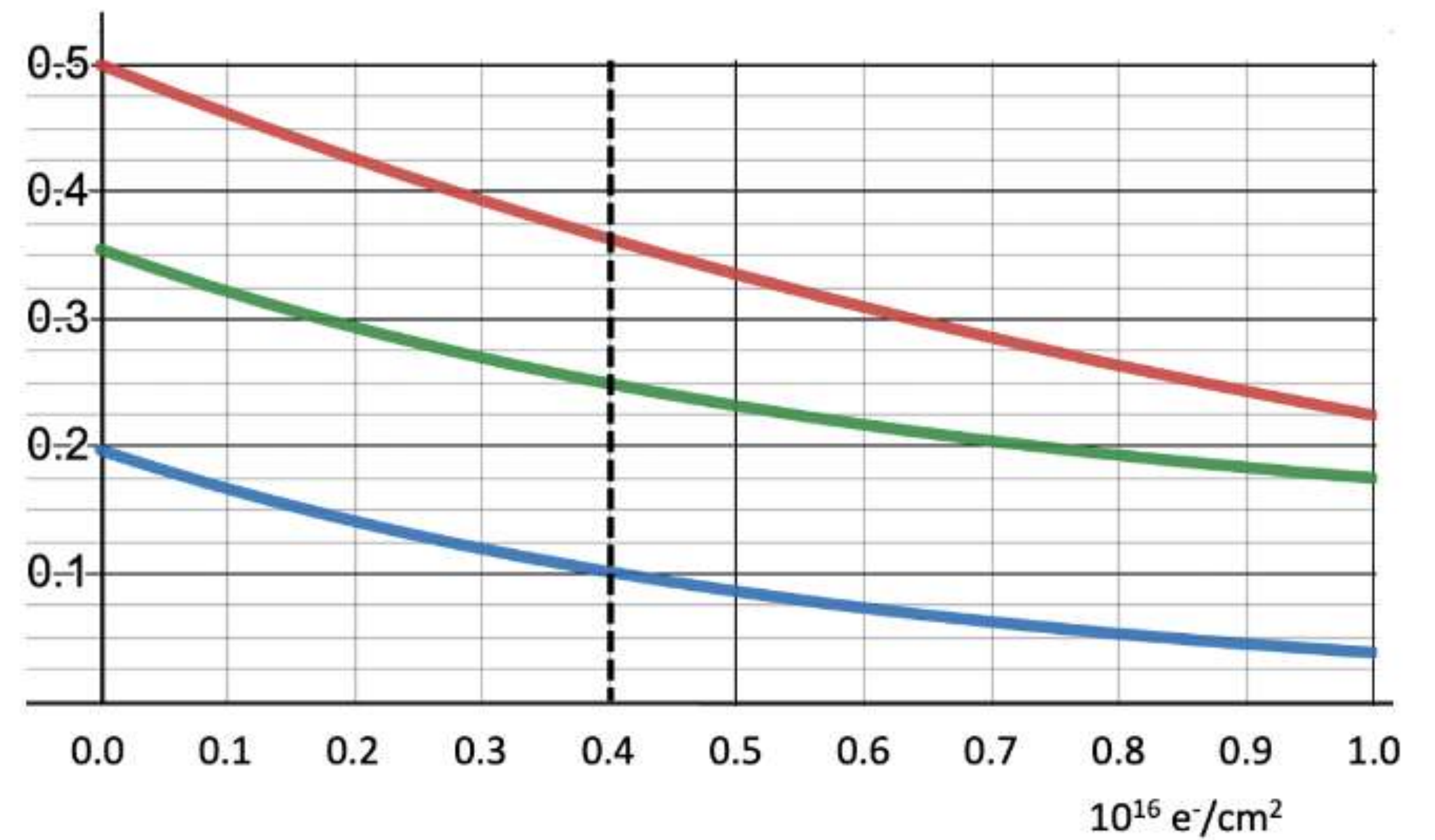
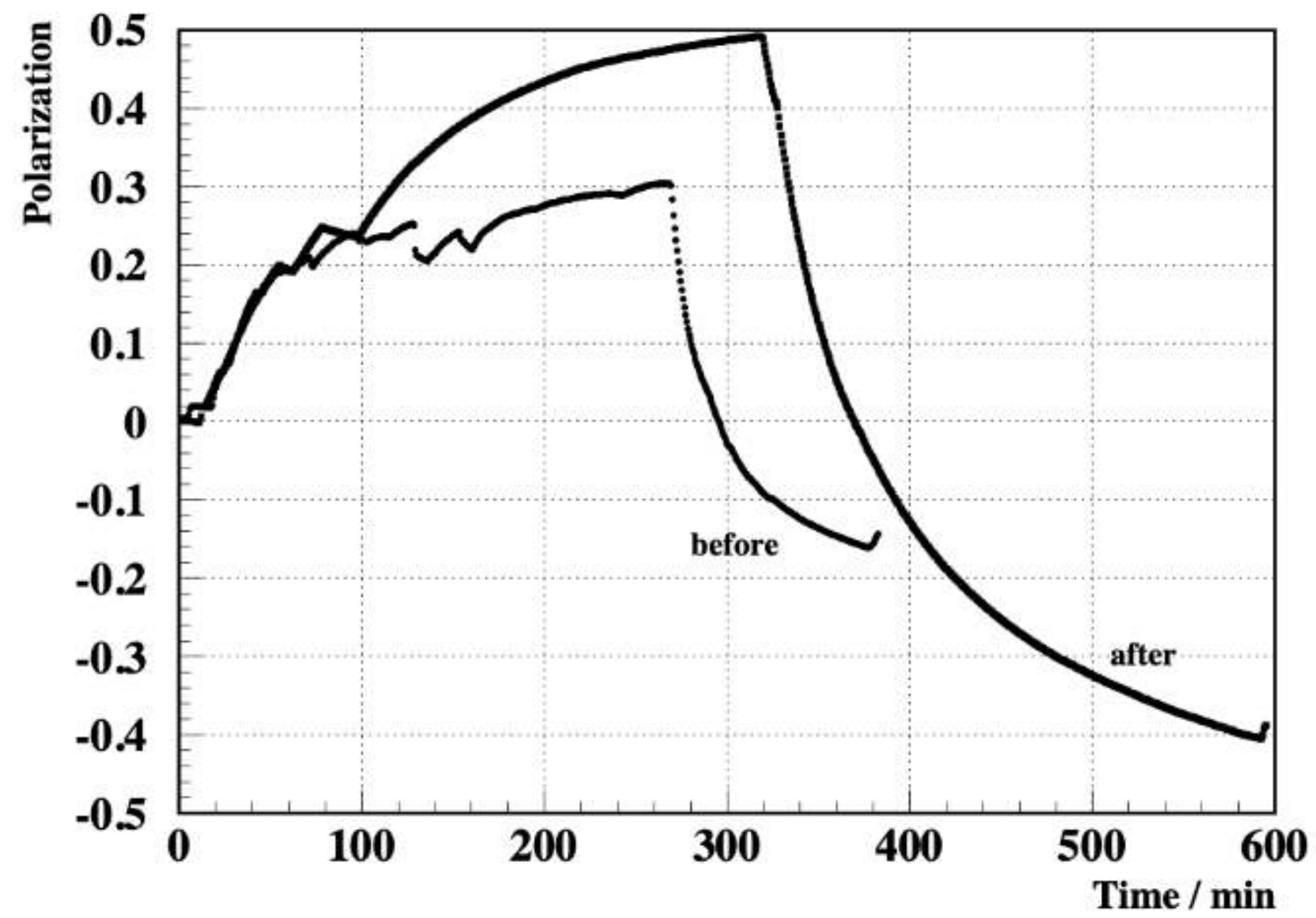
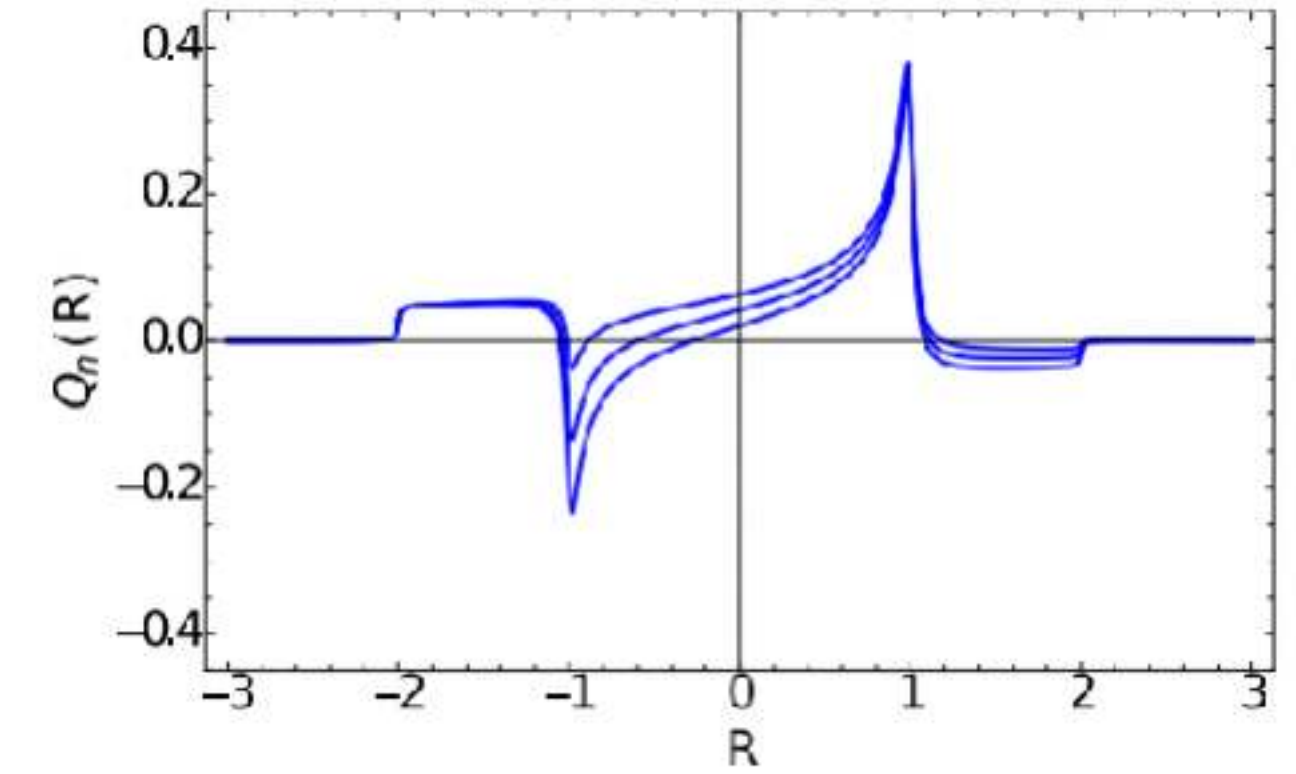
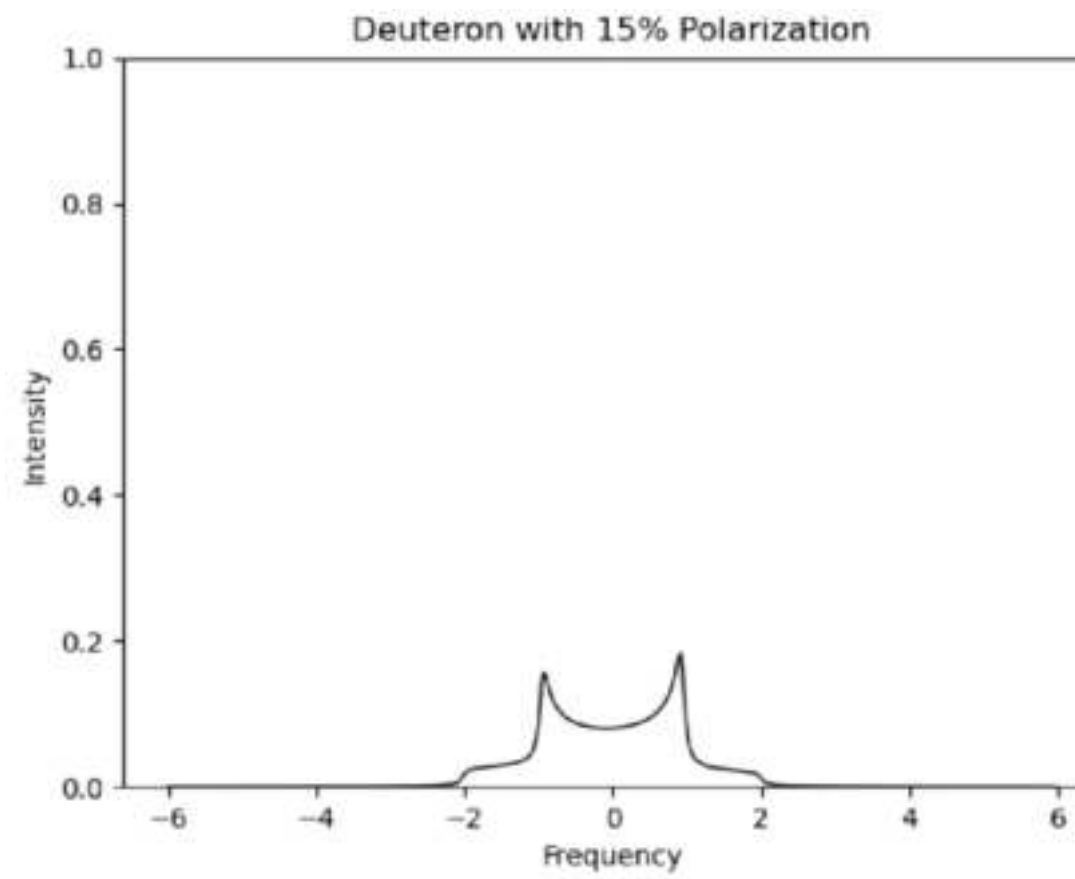

# Charge-4

## The Experimental Situation and Rotation



- ss-RF can be used to enhance the tensor polarization (average) over the course of the experiment even as vector polarization decays
- Modern measurement tools can be implemented to reduce error  $\sim 2\%$
- It benefits us to use (+/-)vector polarized target with zero tensor alternating with a tensor enhanced state, this can be done quick ( $\sim$ secs)

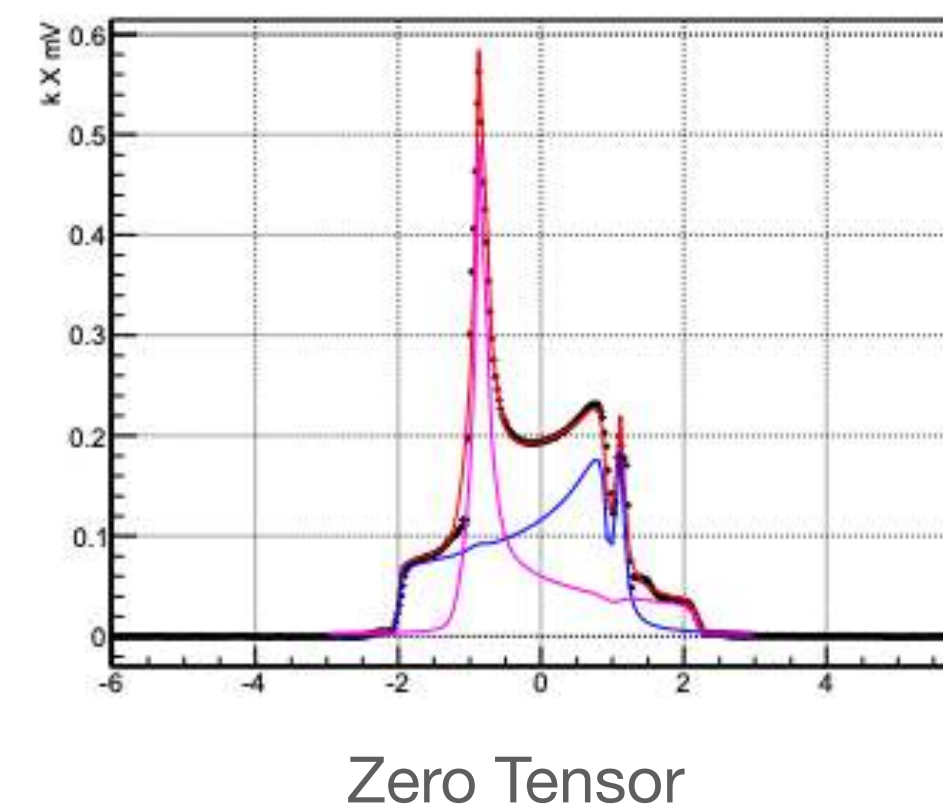
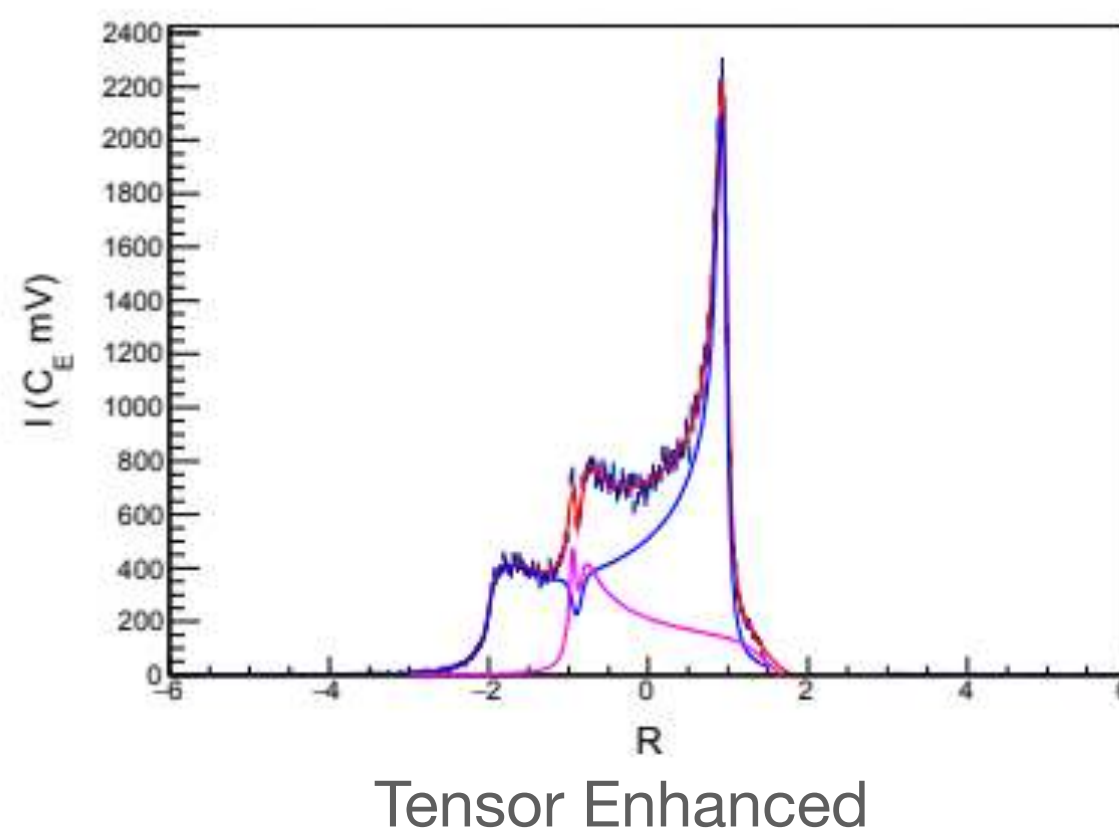

*Fast Tensor Helicity Flips*

# Rotating Targets (work still in progress)

## And results (slow rotation)

- Rotate to TRY to burn one entire absorption line
- Spin Diffusion fights repopulates with rotation but changes for every angle

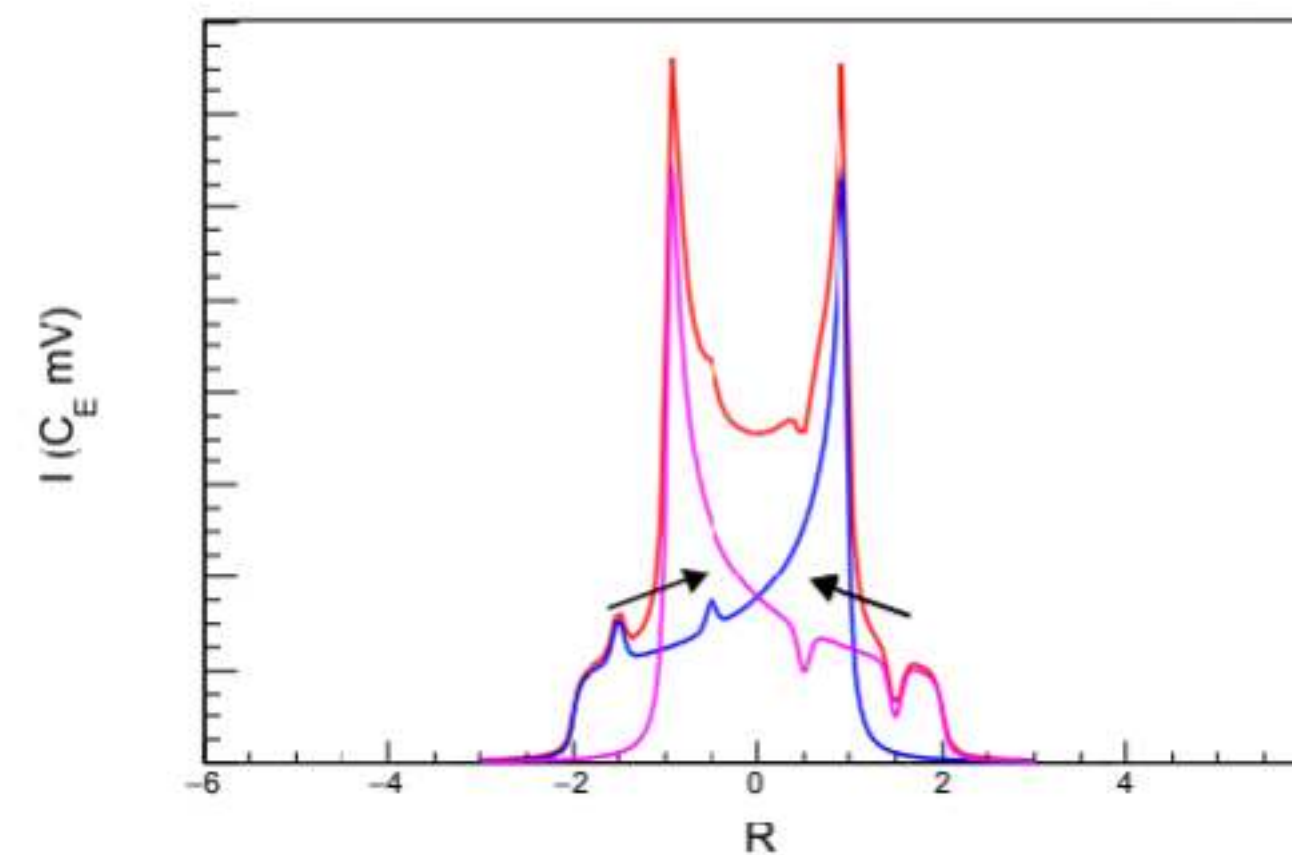
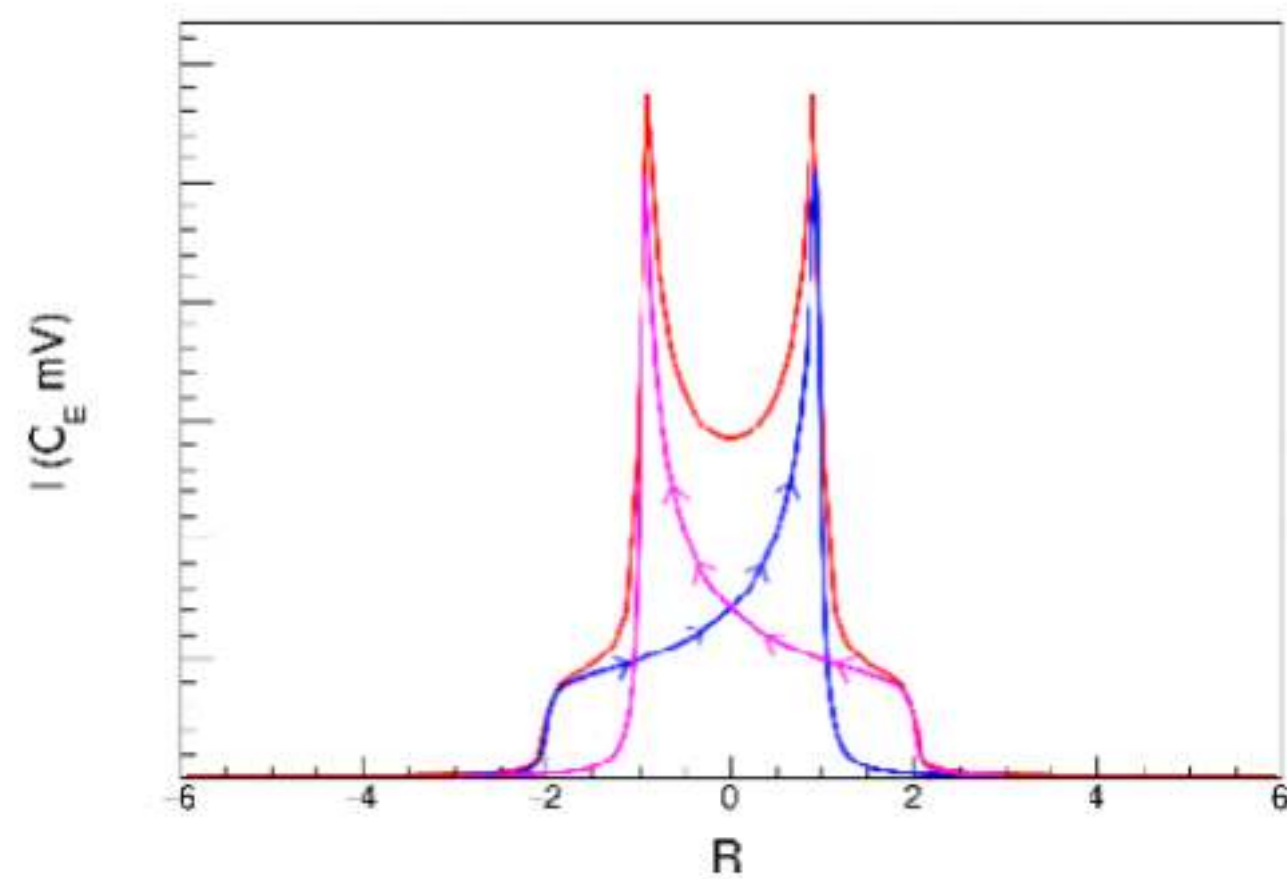

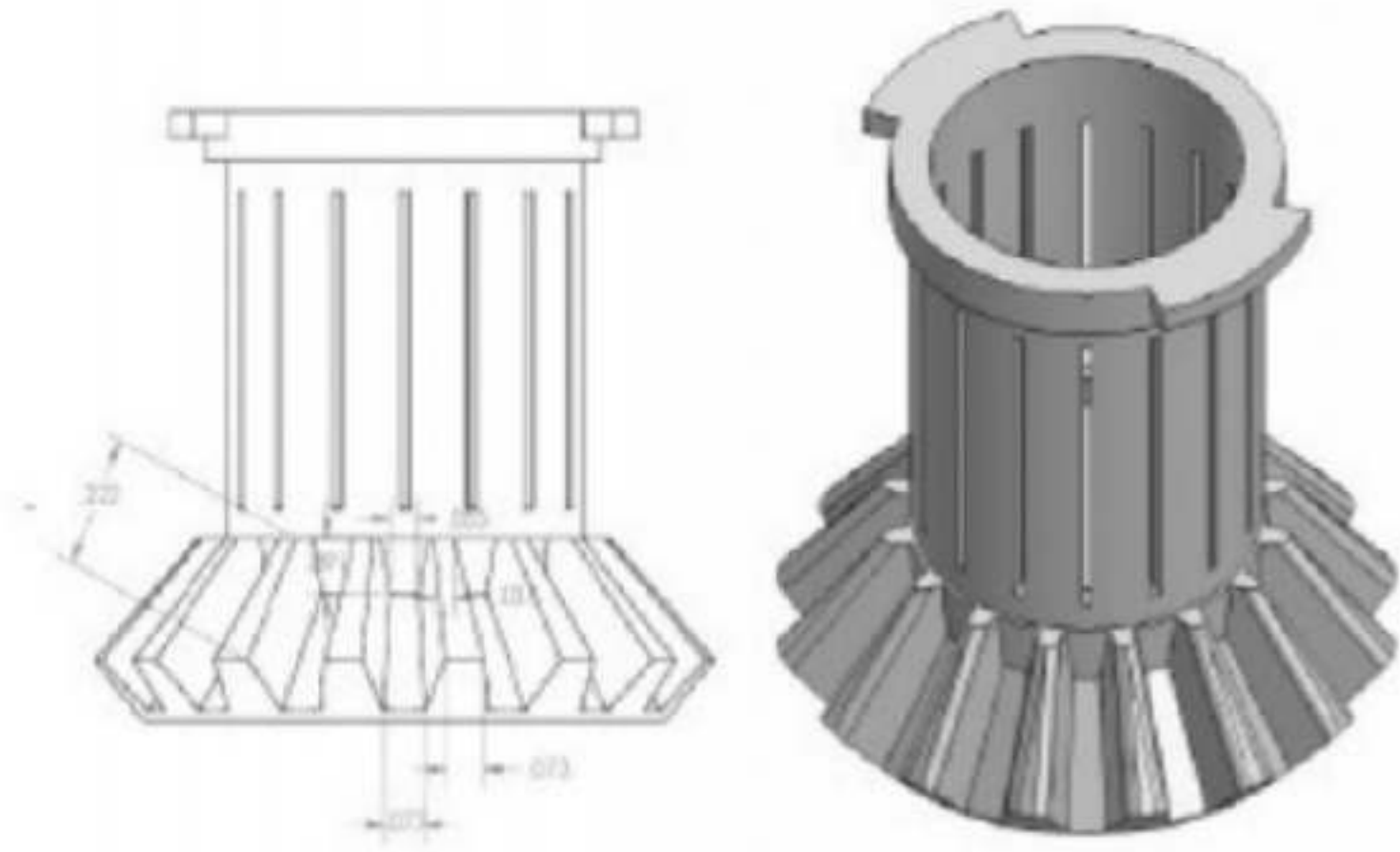

- Kel-F ( $C_2ClF_3$ )<sub>n</sub> cup and driving gear
- Motor outside cryostat
- NMR coil around cup
- Already used with several designs at UVA
- 1 Hz achieved with no problem
- Fixed beam spot

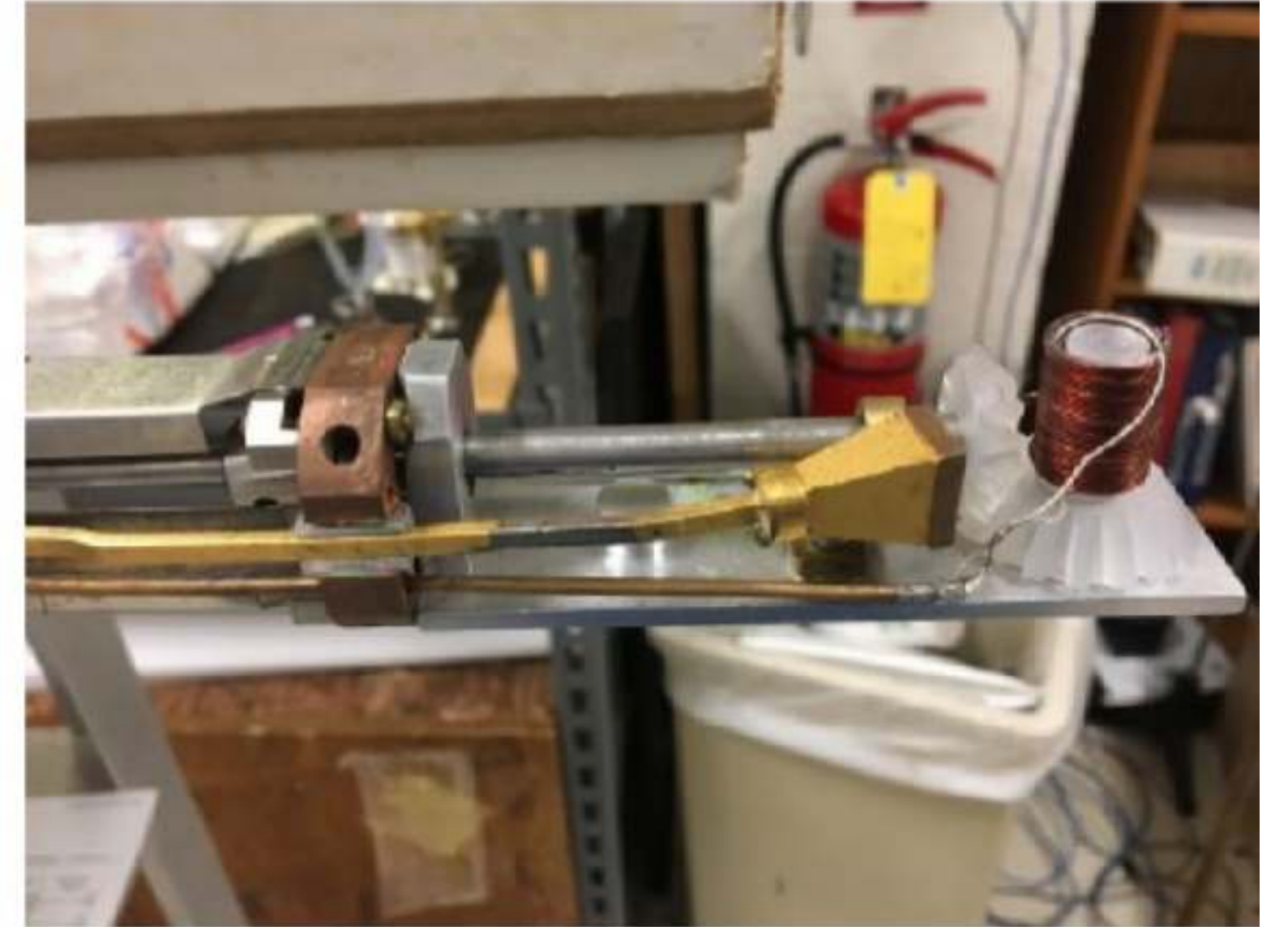
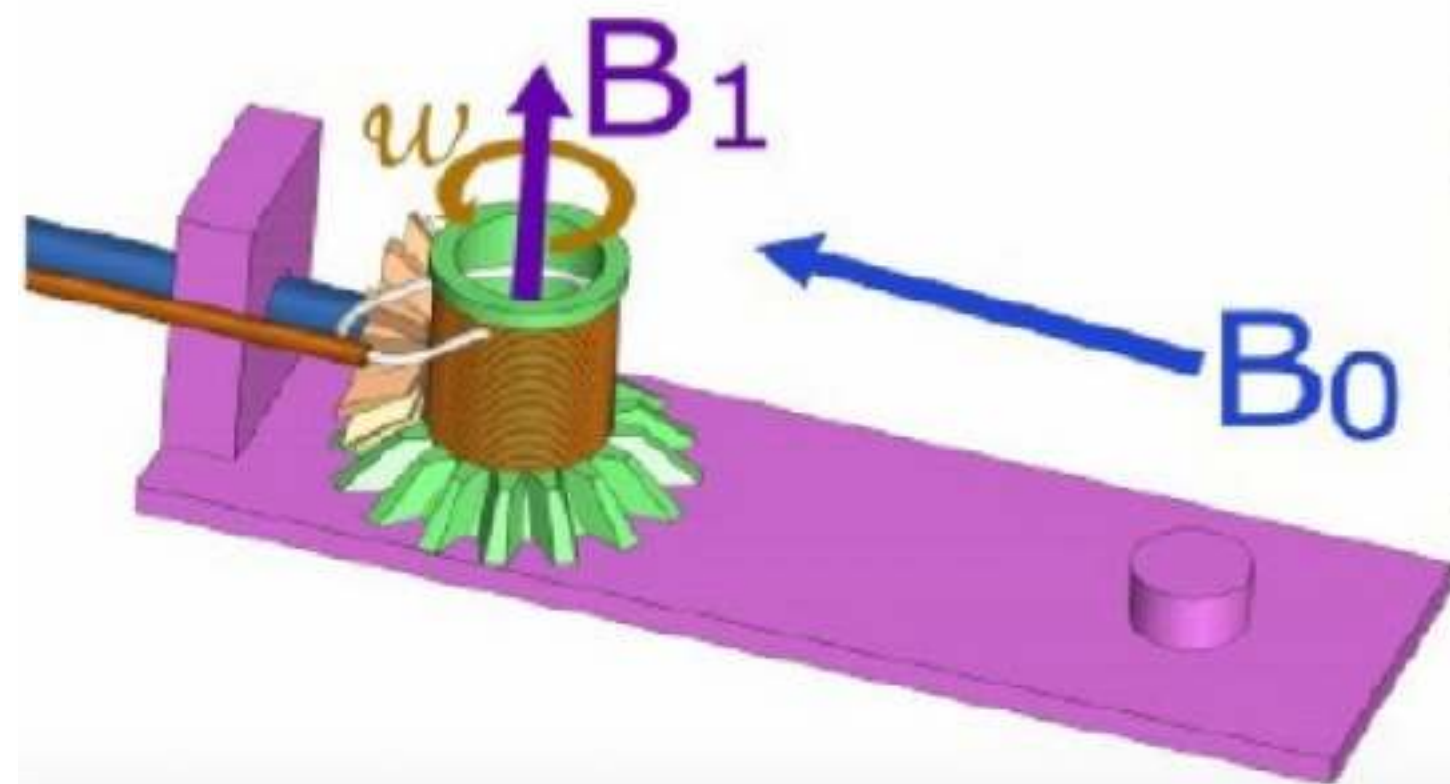

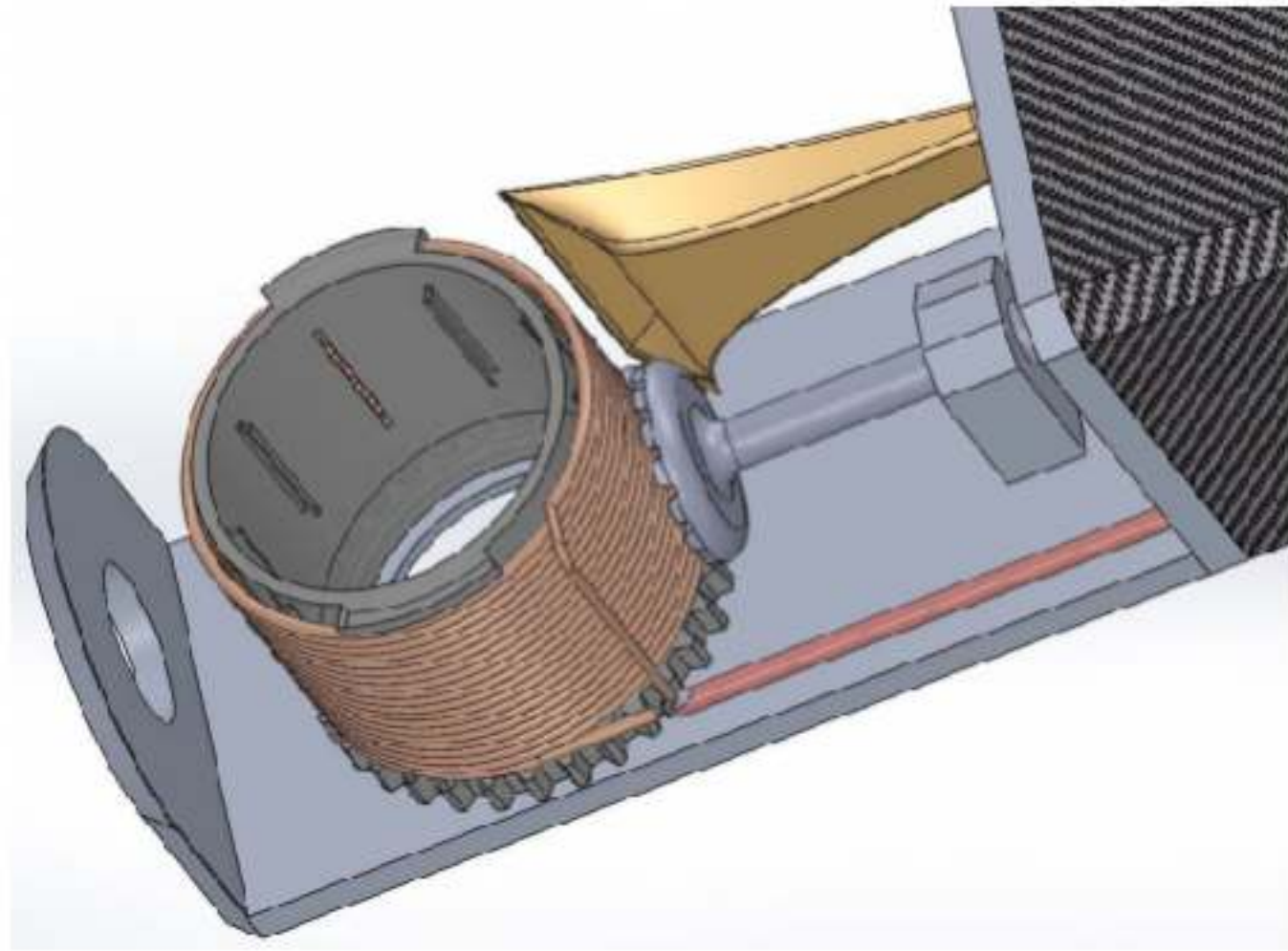

- Motor outside cryostat
- NMR coil around cup
- Already used with several designs at UVA
- 1 Hz achieved with no problem
- Fixed beam spot

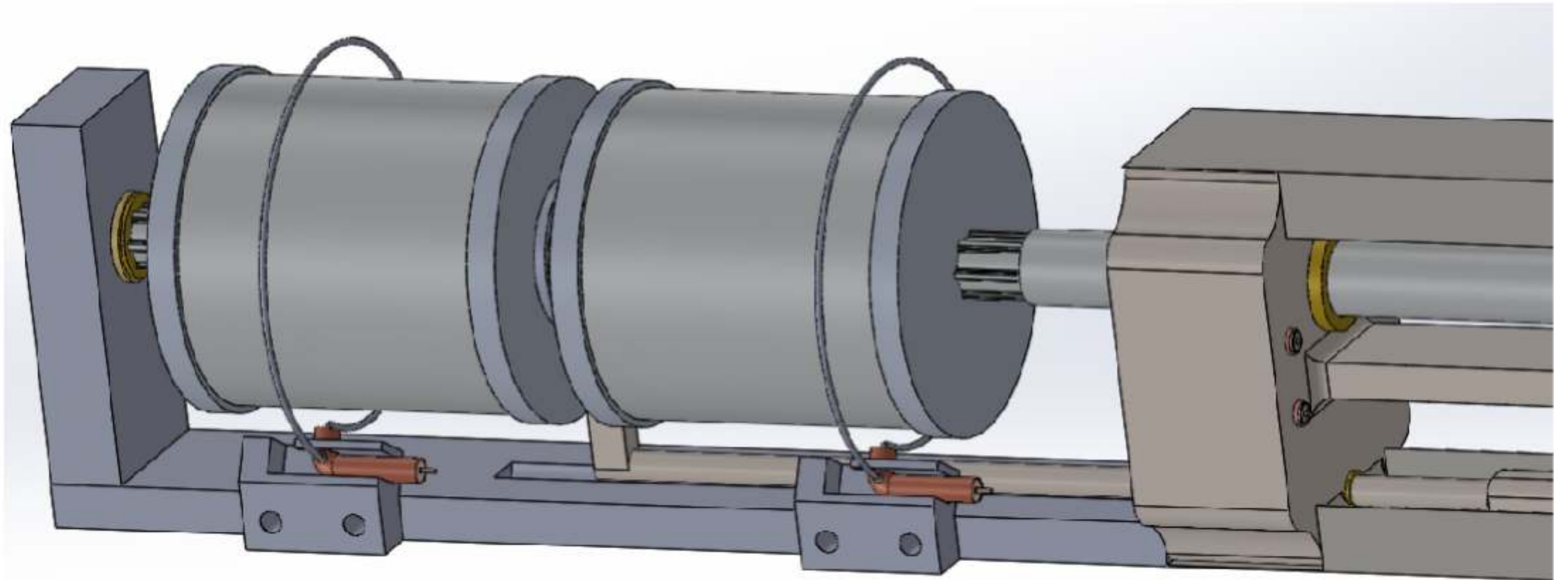
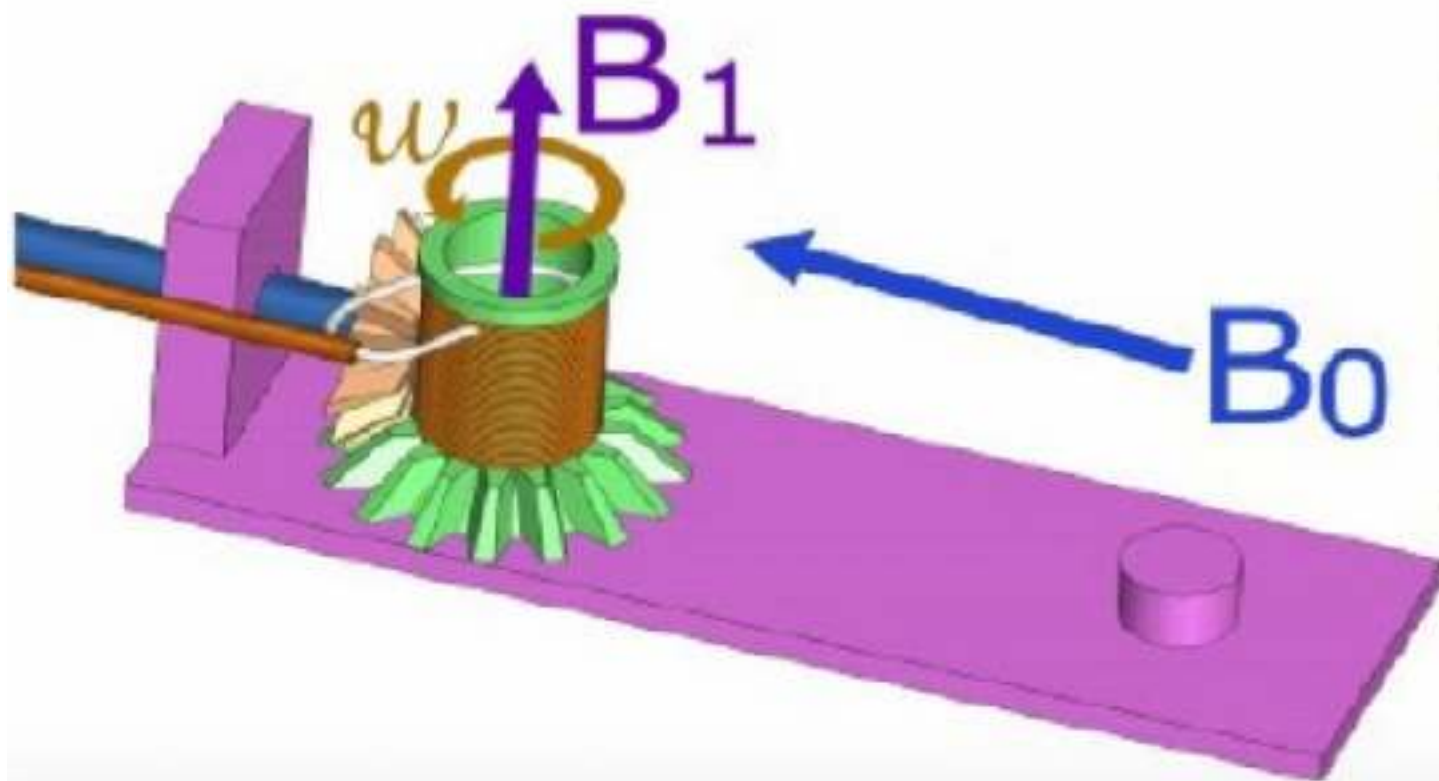

# Rotation Results

10% relative uncertainty is the best we can do with rotation

*At <math>40^\circ</math> with respects to  $B$*

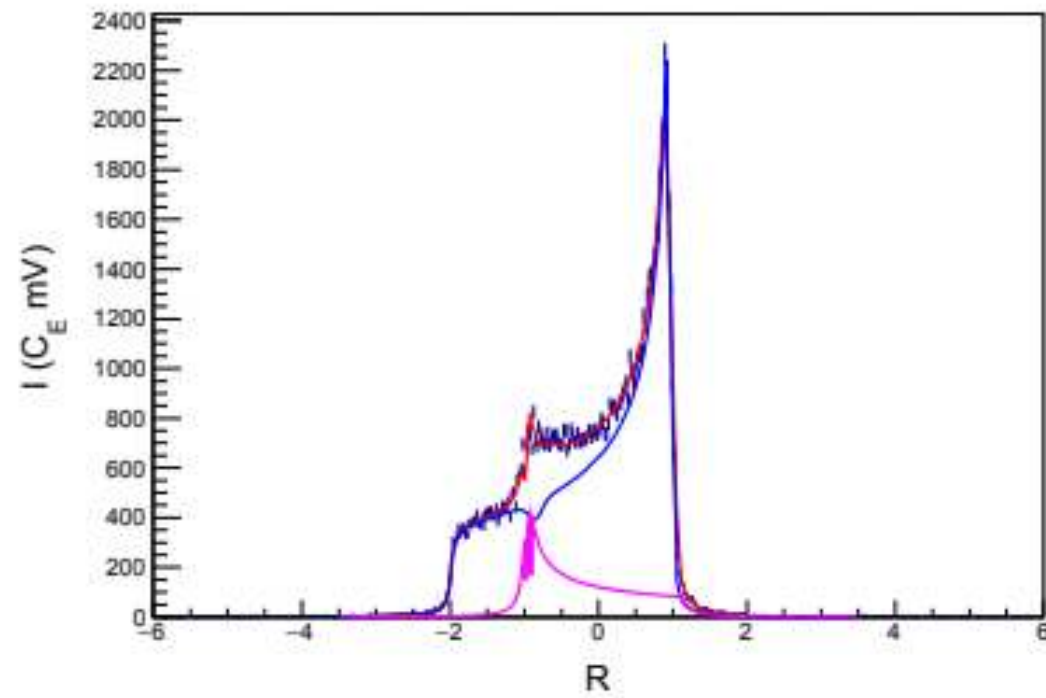

Rotation rate	rss-RF Enhanced Measurements					Relative error
$\Omega^{-1}$	Peak (MHz)	Amp (mV)	Pedestal (MHz)	Amp (mV)	$P_{zz}$ (%)	Error (%)
50	32.65(0.010)	15	32.85(0.015)	45	35.7	8.4
44	32.66(0.000)	10	32.88(0.015)	40	36.5	9.7
40	32.65(0.000)	15	32.88(0.015)	40	36.3	9.3



# Conclusion

- We have the tools to be able to run the b1 and Azz experiments today and get a good measurement
- We need full approval to ramp up our development effort and attract the funds to be able to build modern instrumentation that will allow us to take full advantage of our new technology
- We will continue in the research and development of tensor polarization enhancement and expect to continue to improve

# Backup

# Trend as a function of dose from ssRF alone

